

PRODUCT SPECIFICATION

- Fixture delivered light potential: 120 Lumens/Watt*
- Uniform light distribution
- 90+ CRI LED diode options
- Exceptional binning- less than 2 step MacAdams Ellipse
- Minimum 70% initial lumen output at 70,000 hours
- Standard 0-10v dimming to %10
- Lutron, Eldoled, Dali, and other dimming options
- 5 year system warranty

*Actual fixture efficacy will be dependent on specification. Higher lumens per watt are achieved with lower drive powers. Please contact the factory with questions or for more information.

LUMEN OUTPUT*

| DRIVER OUTPUT | LUMEN OUTPUT (PER FOOT) | |
|-----------------|-------------------------|--------|
| | WATTAGE | LUMENS |
| VERY LOW (VLO) | 4 | 480 |
| LOW (LO) | 6 | 720 |
| STANDARD (SO) | 8 | 945 |
| HIGH (HO) | 10 | 1,185 |
| VERY HIGH (VHO) | 12 | 1,380 |

| DRIVER OUTPUT | PER 4' FIXTURE (TOTAL DELIVERED LUMENS) | |
|-----------------|---|--------|
| | WATTAGE | LUMENS |
| VERY LOW (VLO) | 16 | 1,920 |
| LOW (LO) | 24 | 2,880 |
| STANDARD (SO) | 32 | 3,780 |
| HIGH (HO) | 40 | 4,740 |
| VERY HIGH (VHO) | 48 | 5,520 |

VERY LOW: Considerably underdrives the LEDs to maximize fixture efficacy potential and limit wattage use.

LOW: Underdrives the LEDs for reasonable light output while maintaining low wattage use.

STANDARD: Drives the LEDs for the best combination of lumen output and fixture efficacy.

HIGH: Drive the LEDs at higher capacity for higher lumen output with good efficacy.

VERY HIGH: Drives the LEDs at the highest capacity for the highest lumen output with the best efficacy.

*Lumen output will vary depending on ambient temperature. Cooler ambient and LED color temperatures result in higher luminaire performance. Calculations are based on 4000K LEDs.

LUMINOUS INTENSITY DISTRIBUTION

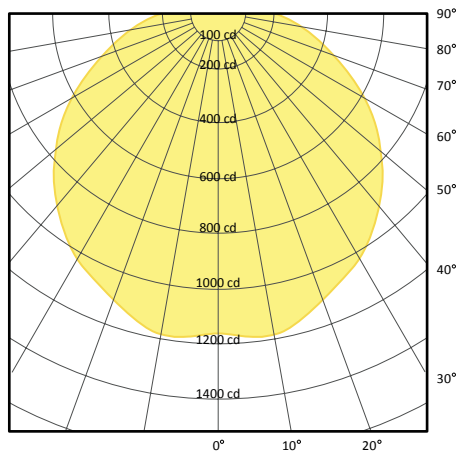

FIXTURE PROPERTIES (AS TESTED)

- 4' nominal length fixture
- Standard Output (SO)
- Total system energy consumption: 32 Watt
- 120 Lumens/Watt
- 4000K 80 CRI LED

ZONAL LUMEN SUMMARY

| ZONE | LUMEN | %LAMP | %FIXTURE |
|--------|-------|-------|----------|
| 0 - 30 | 913 | 21.1% | 24.1% |
| 0 - 40 | 1,496 | 34.6% | 39.5% |
| 0 - 60 | 2,665 | 61.7% | 70.4% |
| 0 - 90 | 3,786 | 87.7% | 100% |

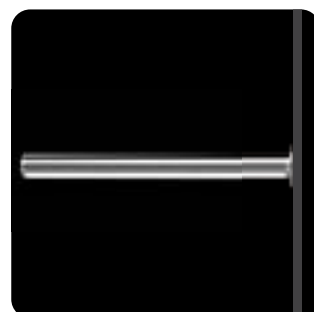
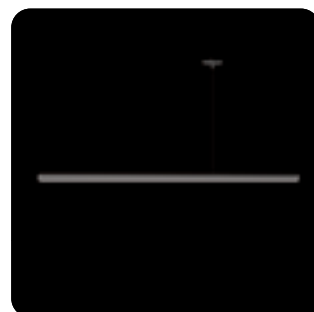

REMOTE DRIVER HOUSING INFORMATION



REMOTE DRIVER HOUSING SIZES

The driver housing length is typically dictated by the options selected. Standard driver housing lengths are as shown. Non standard driver requests may increase or decrease the driver housing length. Specifications are subject to change without notice. Consult factory with questions, requests, or size limitations and we will do our best to accommodate your needs.

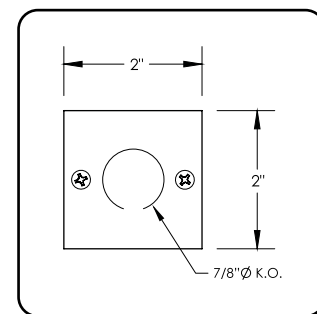
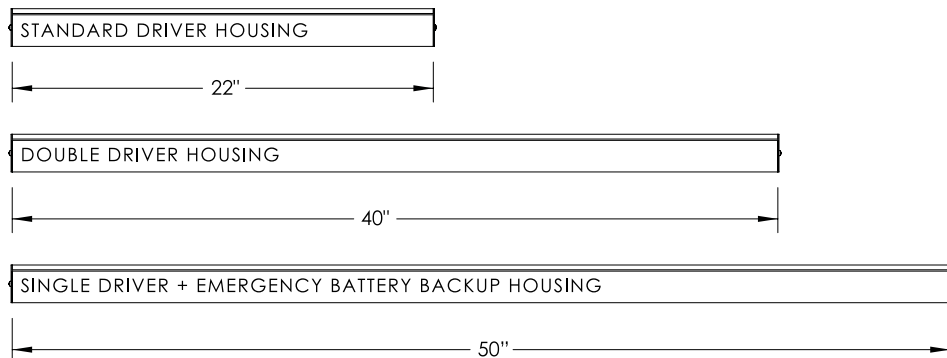

DRIVER HOUSING PROFILE

INSTRUCTIONS

See below for lid removal and installation instructions.

To remove the driver housing lid, use a broad slot screwdriver in the channel as shown here and twist the screwdriver ninety degrees. This may need to be done at both ends of the housing or multiple locations depending on the driver housing length.

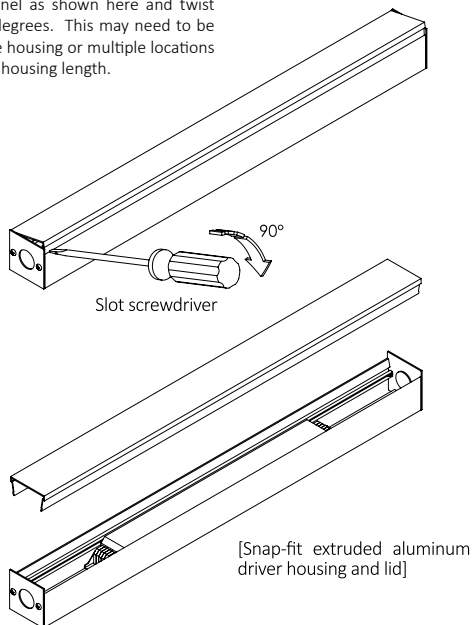

1) Drill mounting holes in the driver housing as needed to secure to a suitable surface. (If needed, a power feed hole can be drilled into the bottom of the housing for certain mounting/power feed applications).

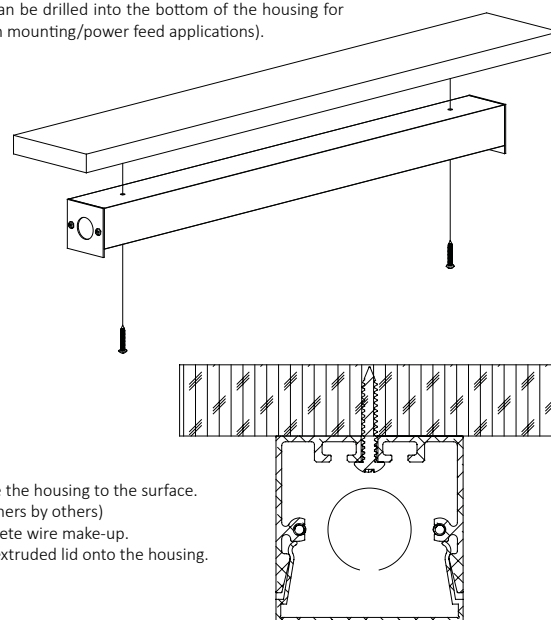

FINISHES

Mill Aluminum (MA) is the standard finish. Satin White and Satin Black powder coat and Satin Clear anodized finishes can be done for a small charge. Custom finishes are possible. Contact the factory for specific finish options, specific requests, RAL colors, or any other questions.



Mill Aluminum (MA)
[Standard Finish]



Satin White (SW)
[Upgrade Finish]



Satin Black (SB)
[Upgrade Finish]



Satin Clear (SC)
[Upgrade Finish]



Custom Finish (CF)
[Upgrade Finish]



NOTES

Other options are possible. Please contact the factory with custom requests.



Lumium Lighting, LLC | 3590 Cadillac Ave, Suite A, Costa Mesa, CA 92626 | Phone: 760.757.2530 | Fax: 760.283.2333 | www.lumiumlighting.com

While we always strive to ensure all website content and product information is current, Lumium Lighting reserves the right to change specifications without notice.
© Lumium Lighting, LLC - All rights reserved.



Lumium
lighting at its element

REMOTE DRIVER HOUSING INFORMATION



REMOTE DRIVER HOUSING SIZES

The driver housing length is typically dictated by the options selected. Standard driver housing lengths are as shown. Non standard driver requests may increase or decrease the driver housing length. Specifications are subject to change without notice. Consult factory with questions, requests, or size limitations and we will do our best to accommodate your needs.

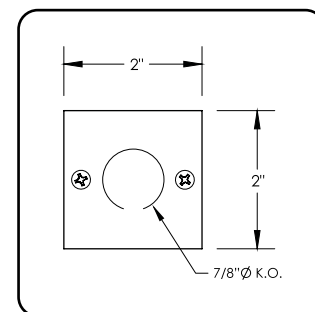
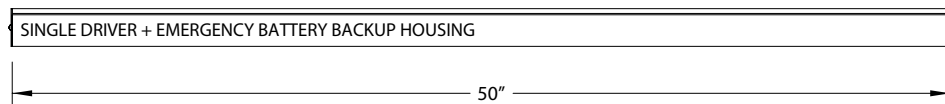

DRIVER HOUSING PROFILE

INSTRUCTIONS

See below for lid removal and installation instructions.

To remove the driver housing lid, use a broad slot screwdriver in the channel as shown here and twist the screwdriver ninety degrees. This may need to be done at both ends of the housing or multiple locations depending on the driver housing length.

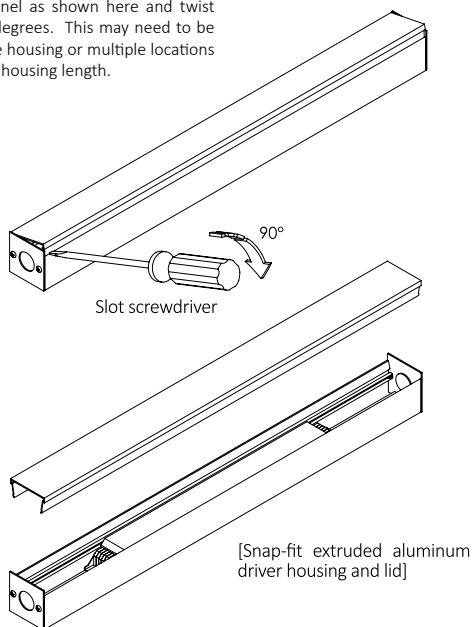

1) Drill mounting holes in the driver housing as needed to secure to a suitable surface. (If needed, a power feed hole can be drilled into the bottom of the housing for certain mounting/power feed applications).

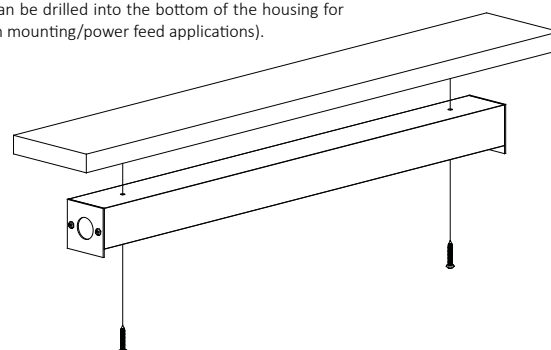

2) Secure the housing to the surface. (Fasteners by others)
3) Complete wire make-up.
4) Snap extruded lid onto the housing.

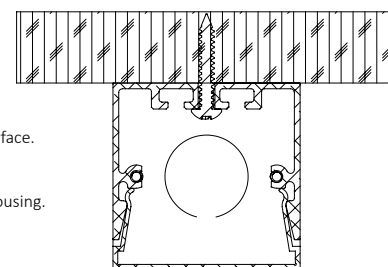

FINISHES

Mill Aluminum (MA) is the standard finish. Satin White and Satin Black powder coat and Satin Clear anodized finishes can be done for a small charge. Custom finishes are possible. Contact the factory for specific finish options, specific requests, RAL colors, or any other questions.



Mill Aluminum (MA)
[Standard Finish]



Satin White (SW)
[Upgrade Finish]



Satin Black (SB)
[Upgrade Finish]



Satin Clear (SC)
[Upgrade Finish]



Custom Finish (CF)
[Upgrade Finish]



NOTES

Other options are possible. Please contact the factory with custom requests.



Lumium Lighting, LLC | 3590 Cadillac Ave, Suite A, Costa Mesa, CA 92626 | Phone: 760.757.2530 | Fax: 760.283.2333 | www.lumiumlighting.com

While we always strive to ensure all website content and product information is current, Lumium Lighting reserves the right to change specifications without notice.
© Lumium Lighting, LLC - All rights reserved.



Lumium
lighting at its element

OPTIONS GUIDE

MOUNTING

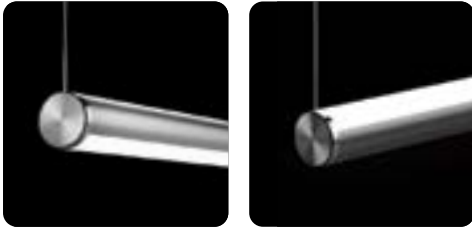

CABLE SUSPENDED (CS)

3/64" aircraft cable suspension system. Oxygen 2 (O2) can be static down-light: Direct (CSD) or static up-light: Indirect (CSI). Standard and custom power cord finishes, sleeve options, and canopy colors offer options to match almost any space. Stainless steel cables come in various lengths (4' is standard) and are field adjustable.

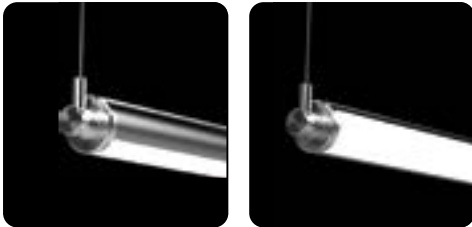

360° ROTATION

ROTATIONAL ARM MOUNT (RAM)

This system uses 5/8" diameter aluminum arms and subtle details in combination with a 360 degree rotational capacity to create some of the most versatile linear fixtures in the architectural market. Standard mounting uses 3-O mud rings (supplied by others) or a 1" optional trim ring for furniture mounted applications. Engineered with no visible fasteners, smooth rotation, and mechanical locking, the RAM system reveals an impressive aesthetic with exceptional versatility.

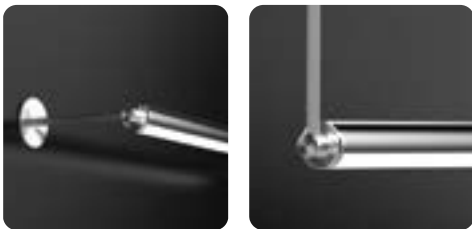

360° ROTATION

ROTATIONAL ARM MOUNT (RAM)

This system uses 5/8" diameter aluminum arms and subtle details in combination with a 360 degree rotational capacity to create some of the most versatile linear fixtures in the architectural market. Standard mounting uses 3-O mud rings (supplied by others) or a 1" optional trim ring for furniture mounted applications. Engineered with no visible fasteners, smooth rotation, and mechanical locking, the RAM system reveals an impressive aesthetic with exceptional versatility.



LARGER THAN 2' FIXTURE

END SURFACE MOUNT (ESM)

Wall Mount. Fixtures are mounted from their ends onto the wall using standard 3-O rings. He2 can be static down-light: Direct (ESMD) or static up-light: Indirect (ESMI). An aircraft cable suspension system will be issued if the fixtures are longer than 2 feet, if needed.



SURFACE MOUNT (SM)

Side Mount Side (SMS) or Side Mount Top (SMT). Side, the fixture is mounted on the wall. Top, the fixture is mounted on the ceiling. Both Side and Top give a static down-light. Top or Side Mount specification denotes the power feed location(s). Optional stand-offs allows for fixtures to be mounted from 1/2" to 12" as well as custom lengths if needed.



OPTIONS GUIDE

CONTINUOUS RUN

Continuous runs are available with all fixtures and have several connection options. Single Seam continuous run options offer smooth section transitions while Component Seams lend to a more dramatic visual statement. The 360 Rotational option enables individual sections to rotate independently of each other, which offers adjustable asymmetric light distribution capacity along with striking appearances such as alternating up/down fixtures or spiral transitions. The flexibility within the rotational option makes for infinite design and functional possibilities.



CONTINUOUS RUN
SINGLE SEAM

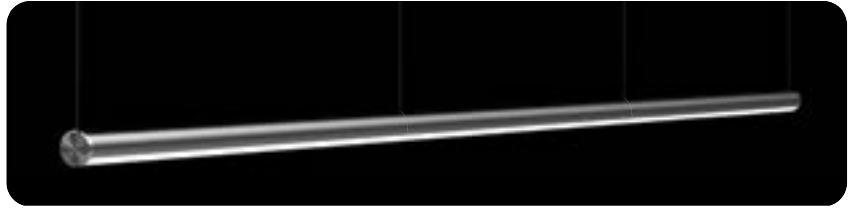

OXYGEN 2 (O2) WITH A SINGLE SEAM CONTINUOUS RUN

CANOPIES

MACHINED

Machined canopies are 4" in diameter and can be anodized as well as powder coated to match a desired color or they can be left with a mill finish for a more striking look. Similar non-power feed options are available with this aesthetic as well. These options do carry a higher cost than standard canopies, but also have an impressive appearance.

44



4" diameter machined power feed and 4" diameter machined non-power feed canopy. Offers a consistent ceiling aesthetic with smaller machined canopies. Mill, anodized, and powder coat finishes available.

41

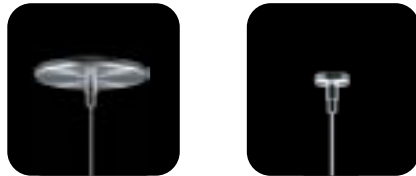

4" diameter machined power feed and 1-1/4" diameter machined non-power feed canopy. Offers minimal ceiling treatment while maintaining the ability to cover mistakes. Requires a 1/4-20 stud securely fastened to the ceiling. Mill, anodized, and powder coat finishes available.

40



4" diameter machined power feed canopy and no canopy on the non-power feed side. Minimal aesthetic. Requires a 1/4-20 stud securely attached to the ceiling. Works well with continuous runs where the power can be carried inside the fixture. Mill, anodized, and powder coat finishes available.

CUSTOM

Custom canopy options are available and can look spectacular in certain applications. Contact the factory with all custom requests or with any questions.



CUSTOM POWDER COAT



CUSTOM ANODIZE



CUSTOM SHAPE



Lumium Lighting, LLC | 3590 Cadillac Ave, Suite A, Costa Mesa, CA 92626 | Phone: 760.757.2530 | Fax: 760.283.2333 | www.lumiumlighting.com

While we always strive to ensure all website content and product information is current, Lumium Lighting reserves the right to change specifications without notice.
© Lumium Lighting, LLC - All rights reserved.



Lumium
lighting at its element

OPTIONS GUIDE

COLOR AND FINISH

Standard finish configurations are Satin Clear (SC) housing with Machined Finish (MF) machined components (end caps, knuckles, cover plates, etc.). The incredibly clean detail within all of the machined components lends to an incredibly high end aesthetic with two tone finish. Numerous custom anodizing and powder coated finishes are available as well. If you have a particular color/finish treatment in mind, please contact the factory and we will do our best to accommodate your project needs.

STANDARD



SATIN CLEAR
ANODIZING

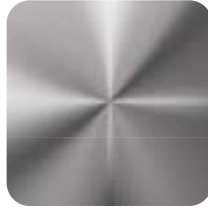

MACHINED
COMPONENTS

CUSTOM



MATTE BLACK



GLOSS BLACK



BRONZE



MILL ALUMINUM



SPECULAR



SATIN WHITE



GLOSS WHITE



COLOR POWDER COAT



COLOR ANODIZE



RAL COLORS

FINISHED CONFIGURATION



THALLIUM 2 (Th2)

Cable Suspended Rotational mount system with two-tone finish, Satin Clear housing and Machined Finish components.

COVER PLATES

Cover plates are standard for Rotational Arm Mounting (RAM) Systems. Standard options are Flat (FT), Curved (CV), or Trim Ring (TR). With certain applications, cover plates or trim rings may not be necessary. Contact factory with questions or for more information. Custom cover plates are also available. If a certain aesthetic is desired, please contact the factory to review any concepts and we will do our best to bring your vision to life.

STANDARD

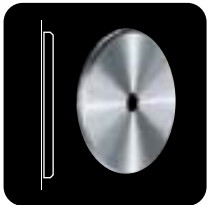

FLAT (CPFT)

Flat has a 4" diameter cover plate for use with a 3-O mud ring.

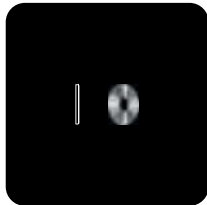

TRIM RING (TR)

1-1/4" diameter trim ring Can be used in applications such as desk mounting.

CUSTOM

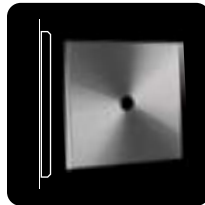

SQUARE

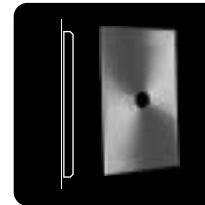

TALL RECTANGLE



CUSTOM

CUSTOM



Lumium Lighting, LLC | 3590 Cadillac Ave, Suite A, Costa Mesa, CA 92626 | Phone: 760.757.2530 | Fax: 760.283.2333 | www.lumiumlighting.com

While we always strive to ensure all website content and product information is current, Lumium Lighting reserves the right to change specifications without notice.
© Lumium Lighting, LLC - All rights reserved.



Lumium
lighting at its element