

Nitrogen 3

CABLE SUSPENDED (CS)

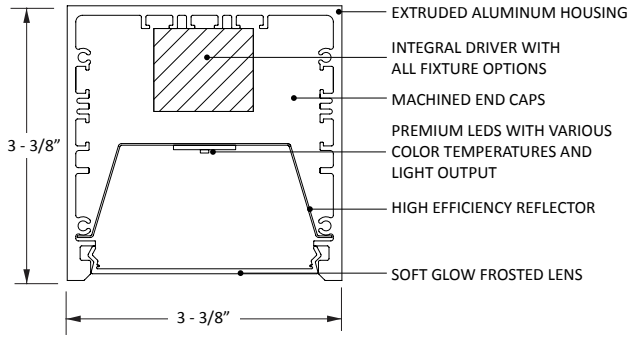

FEATURES:

- 3/64" aircraft cable suspension system
- High transmission frosted lenses with no diode imaging
- No visible fasteners
- Extruded aluminum housing
- Dimmable/Programmable drivers for controllable light output
- High efficacy LEDs with 5 year warranty
- Under 2 steps MacAdams Ellipse Binning
- 3/8" thick machined end caps
- 360 rotation option- with mechanical locking
- Slightly recessed beveled lens housing



MITERED

PRODUCT SPECIFICATION

NOTE: All options *italicized in gray* may increase lead times and/or incur higher costs - please consult factory with questions.

FIXTURE TYPE	MOUNTING/ ORIENTATION	NOMINAL LENGTH*	COLOR TEMP	LED DRIVE POWER	VOLTAGE	DRIVER
N3						
N3 Nitrogen 3	CSD Cable Suspended - DIRECT CSI Cable Suspended - INDIRECT CSR Cable Suspended - ROTATIONAL	1' 1' 1-3/8"*** 2' 2' 1-3/8"*** 3' 3' 1-3/8"*** 4' 4' 1-3/8"*** 5' 5' 1-3/8"*** 6' 6' 1-3/8"*** 7' 7' 1-3/8"*** 8' 8' 1-3/8"*** 12' 12' 1-3/8"*** CR Continuous Run (Specify length in feet)	27K 2700K 30K 3000K 35K 3500K 40K 4000K 50K 5000K	VLO Very Low Output 390 lumens/ft. (4w/ft.) LO Low Output 590 lumens/ft. (6w/ft.) SO Standard Output 755 lumens/ft. (8w/ft.) HO High Output 970 lumens/ft. (10w/ft.) VHO Very High Output 1,130 lumens/ft. (12w/ft.) DHO Dual High Output 1,945 lumens/ft. (12w/ft.) CPO Custom Power Output Consult factory CPO:	UNV Universal (120-277V)	ND Non-Dimming 0-10V DIMMING 10D 10% DIM 1D 1% DIM LUTRON LDE1 Lutron EcoSystem 1% "Soft on" (Digital) LDES Lutron EcoSystem 5% 5-Series (Digital) DALI DALI Digital Addressable Lighting Interface
		*Dimensions are for reference only. Contact factory for more specific information or shop drawings. **Odd lengths may incur slightly higher per foot pricing.				

HOUSING FINISH	HARDWARE* DETAIL FINISH	CANOPY SIZE OPTIONS*	CANOPY FINISH	POWER CORD COLOR	AIRCRAFT CABLE LENGTH*	OPTIONS/ CUSTOMIZATION*
SC Satin Clear Anodize (Standard) SW Satin White (Powder Coat) MB Matte Black (Powder Coat) CF Custom Finish* (Consult Factory)	MC Machine Component MI Mitered Corners CF Custom Finish (Consult Factory) CF NOTE: MF option is strongly recommended. Other options will result in higher costs and potentially longer lead times. **Hardware* refers to the end caps and knuckles (knuckles only for the "Rotational" option).	44 4" Power feed canopy 4" Non-power feed canopy 41 4" Power feed canopy 1" Non-power feed canopy 40 4" Power feed canopy Canopy only at power feed	MF Machine Finish (Standard) SW Satin White CF Custom Finish* *Just about any finish is possible. For the 4" machined canopies, MF is strongly recommended. Contact the factory with questions or requests.	W White G Gray B Black CC Custom Cord* CC: * Consult factory.	2 2' 4 4' 6 6' 8 8' CL Custom Length** (Specify in feet IE: CL10 for 10') CL	XX No EMB or Customization EMB7 7 Watt battery back-up** (Approximately 600 lumens) EMB12 12 Watt battery back-up** (Approximately 1,000 lumens) 90 90+ CRI LED BOARDS (2700K - 4000K only) CCP Corners/patterns* CD Custom Driver* CR Customization Requested* WSN Night Air WSE Enlighted WSW Wavelinx WSL Lutron Vive *Consult factory for all custom options or custom concept requests. NOTE: Customization may incur higher costs and/or increased lead times. **The EMB12 is slightly more expensive than the EMB7 option (BOTH OPTIONS ARE INTEGRAL).
*RAL and color match are available.		*See options section and installation instructions for more information.			*Cables are field adjustable. ** Consult factory to confirm specific length.	

SPECIFICATION INFORMATION

NOTE: All options *italicized in gray* may increase lead times and/or incur higher costs- please consult factory with questions.

GENERAL NOTES:

All fixtures are **UL listed** for **dry** and **damp** locations.

INTEGRAL DRIVER for all options.

Please contact the factory with any specification questions.

FIXTURE ORIENTATION:

Direct (CSD) for downlight applications.

Indirect (CSI) for uplight applications.

Rotational (CSR) for adjustable applications: 360 degree rotational capacity with locking mechanism.

DRIVER: [INTEGRAL]

1) NON-DIMMING: As described... this fixture will not dim.

2) DIMMING: 0-10v: 1%, 10% :: Lutron: 2-wire Forward phase (Hi-Lume 1%), Ecosystem to 1% (Soft On), Ecosystem to 5% (5 Series). "DALI"- Specify driver. See "Dimming Options" on subsequent pages for more information. For other dimming options, consult the factory.

3) EMERGENCY: Specify EMB under the Options/Customization category at the end of the cut sheet along with the desired lumen output (600 or 1,000 lumens - the latter is slightly more costly).

4) Drivers are programmed according to our standard lumen packages or to custom watt/lumen package requirements.

5) Consult factory with any questions or specification requirements.

FINISHES:

The standard finish is a Satin Clear anodized housing with Machine Finished hardware. Machined finish is preferable for machined components (Hardware Detail) - Powder coating these parts may result in additional costs. Consult the factory with any questions about standard or custom finishing options.

CUSTOMIZATION:

We have numerous custom options available. However, if there is something unique required for a project, from simple options to complete custom requests, we are more than willing to entertain any creative notions you might have. Just ask.



Lumium Lighting, LLC | 3590 Cadillac Ave, Suite A, Costa Mesa, CA 92626 | Phone: 760.757.2530 | Fax: 760.283.2333 | www.lumiumlighting.com

While we always strive to ensure all website content and product information is current, Lumium Lighting reserves the right to change specifications without notice.
© Lumium Lighting, LLC - All rights reserved.



Lumium
Lighting at its element

Nitrogen 3

ROTATIONAL ARM MOUNT (RAM)

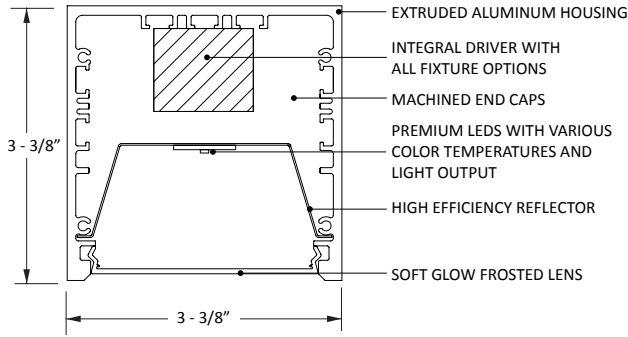

FEATURES:

- 5/8" diameter rigid tube mounting system
- High transmission frosted lenses with no diode imaging
- No visible fasteners
- Extruded aluminum housing
- Dimmable/Programmable drivers for controllable light output
- High efficacy LEDs with 5 year warranty
- Under 2 steps MacAdams Ellipse Binning
- 3/8" thick machined end caps
- 360 rotation option- with mechanical locking
- Slightly recessed beveled lens housing

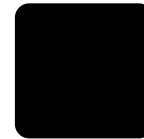

PRODUCT SPECIFICATION

NOTE: All options *italicized in gray* may increase lead times and/or incur higher costs - please consult factory with questions.

FIXTURE TYPE	MOUNTING/ ORIENTATION	NOMINAL LENGTH*	COLOR TEMP	LED DRIVE POWER	VOLTAGE	DRIVER	HOUSING FINISH
N3 Nitrogen 3	RAM Rotational Arm Mount	1' 1-3/8"*** 2' 2-1/8" 3' 3-1/8"*** 4' 4-1/8" 5' 5-1/8"*** 6' 6-1/8" 7' 7-1/8"*** 8' 8-1/8" 12' 12-1/8"*** CR Continuous Run (Specify length in nominal feet)	27K 2700K 30K 3000K 35K 3500K 40K 4000K 50K 5000K	VLO Very Low Output 390 lumens/ft (4w/ft.) LO Low Output 590 lumens/ft. (6w/ft.) SO Standard Output 755 lumens/ft. (8w/ft.) HO High Output 970 lumens/ft. (10w/ft.) VHO Very High Output 1,130 lumens/ft. (12w/ft.) DHO Dual High Output 1,945 lumens/ft. (12w/ft.) CPO Custom Power Output Consult factory CPO:	UNV Universal (120-277v)	ND Non-Dimming 0-10v DIMMING 10D 10% DIM 1D 1% DIM LUTRON LDE1 Lutron EcoSystem 1% "Soft on" (Digital) LDES Lutron EcoSystem 5% 5-Series (Digital) DALI DALI Digital Addressable Lighting Interface	SC Satin Clear Anodize (Standard) SW Satin White (Powder Coat) MB Matte Black (Powder Coat) CF Custom Finish* (Consult Factory) CF *RAL and color match are available.

HARDWARE* DETAIL FINISH	ARM LENGTH*	MOUNTING / COVER PLATE	OPTIONS/ CUSTOMIZATION*
MF Machine Finish (Standard) CF Custom Finish (Consult Factory)	3 3" 6 6" 9 9"*** 12 12"*** CAL Custom Arm Length- Consult factory	4CPF Flat 4" diameter CCP Cover Plate - For use with a 3-O mud ring Custom Cover Plate (Consult factory)	XX No EMB or Customization EMB7 7 Watt battery back-up** (Approximately 600 lumens) EMB12 12 Watt battery back-up** (Approximately 1,000 lumens) 90 90+ CRI LED BOARDS (2700K - 4000K only) CCP Corners/patterns* CD Custom Driver* CR Customization Requested* WSN Nlight Air WSE Enlighted WSW Wavelinx WSL Lutron Vibe

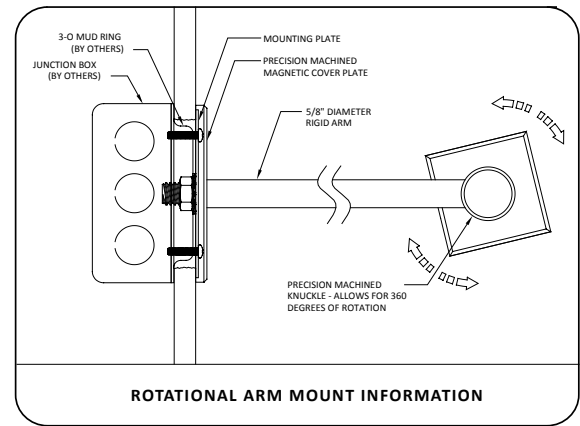

SPECIFICATION INFORMATION

NOTE: All options *italicized in gray* may increase lead times and/or incur higher costs- please consult factory with questions.

GENERAL NOTES:

All fixtures are **UL listed for dry and damp** locations.
INTEGRAL DRIVER for all options.
 Please contact the factory with any specification questions.

FIXTURE ORIENTATION:

Direct (CSD) for downlight applications.
 Indirect (CSI) for uplight applications.
 Rotational (CSR) for adjustable applications: 360 degree rotational capacity with locking mechanism.

DRIVER: [INTEGRAL]

- 1) NON-DIMMING: As described... this fixture will not dim.
- 2) DIMMING: 0-10v: 1%, 10% :: Lutron: 2-wire Forward phase (Hi-Lume 1%), Ecosystem to 1% (Soft On), Ecosystem to 5% (5 Series). "DALI"- Specify driver. See "Dimming Options" on subsequent pages for more information. For other dimming options, consult the factory.
- 3) EMERGENCY: Specify EMB under the Options/Customization category at the end of the cut sheet along with the desired lumen output (600 or 1,000 lumens - the latter is slightly more costly).
- 4) Drivers are programmed according to our standard lumen packages or to custom watt/lumen package requirements.
- 5) Consult factory with any questions or specification requirements.

FINISHES:

The standard finish is a Satin Clear anodized housing with Machine Finished hardware. Machined finish is preferable for machined components (Hardware Detail) - Powder coating these parts may result in additional costs. Consult the factory with any questions about standard or custom finishing options.

CUSTOMIZATION:

We have numerous custom options available. However, if there is something unique required for a project, from simple options to complete custom requests, we are more than willing to entertain any creative notions you might have. Just ask.



Nitrogen 3

SURFACE MOUNT (SM)

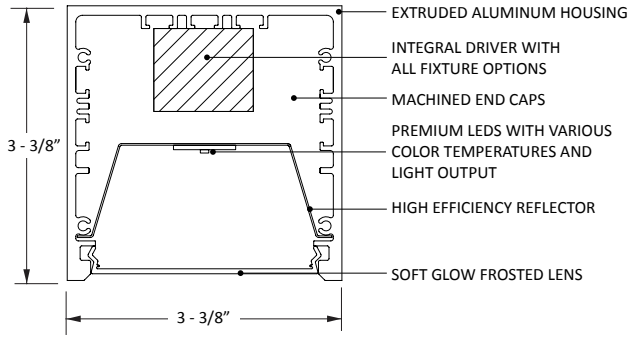

FEATURES:

- Ceiling or wall mounting system
- High transmission frosted lenses with no diode imaging
- No visible fasteners
- Extruded aluminum housing
- Dimmable/Programmable drivers for controllable light output
- High efficacy LEDs with 5 year warranty
- Under 2 steps MacAdams Ellipse Binning
- 3/8" thick machined end caps
- Slightly recessed beveled lens housing



PRODUCT SPECIFICATION

NOTE: All options *italicized in gray* may increase lead times and/or incur higher costs - please consult factory with questions.

FIXTURE TYPE	MOUNTING	NOMINAL LENGTH*	COLOR TEMP	LED DRIVE POWER	VOLTAGE	DRIVER	HOUSING FINISH
N3 Nitrogen 3	SMS Surface Mount - SIDE SMT Surface Mount - TOP	1' 1' 1-3/8"*** 2' 2' 1-3/8"*** 3' 3' 1-3/8"*** 4' 4' 1-3/8"*** 5' 5' 1-3/8"*** 6' 6' 1-3/8"*** 7' 7' 1-3/8"*** 8' 8' 1-3/8"*** 12' 12' 1-3/8"*** CR Continuous Run (Specify length in nominal feet)	27K 2700K 30K 3000K 35K 3500K 40K 4000K 50K 5000K	VLO Very Low Output 390 lumens/ft (4w/ft.) LO Low Output 590 lumens/ft. (6w/ft.) SO Standard Output 755 lumens/ft. (8w/ft.) HO High Output 970 lumens/ft. (10w/ft.) VHO Very High Output 1,130 lumens/ft. (12w/ft.) DHO Dual High Output 1,945 lumens/ft. (12w/ft.) CPO Custom Power Output Consult factory CPO:	UNV Universal (120-277v)	ND Non-Dimming 0-10v DIMMING 10D 10% DIM 1D 1% DIM LUTRON LDE1 Lutron EcoSystem 1% "Soft on" (Digital) LDES Lutron EcoSystem 5% 5-Series (Digital) DALI DALI Digital Addressable Lighting Interface	SC Satin Clear Anodize (Standard) SW Satin White (Powder Coat) MB Matte Black (Powder Coat) CF Custom Finish* (Consult Factory) CF

*Dimensions are for reference only. Contact factory for more specific information or shop drawings.
 **Odd lengths may incur slightly higher per foot pricing.

*RAL and color match are available.

HARDWARE* DETAIL FINISH	STAND OFF DISTANCE	OPTIONS/CUSTOMIZATION*
MF Machine Finish (Standard) CF Custom Finish (Consult Factory) CF	0 Flush .5 Half inch 1 1" 3 3" 6 6" CU_ Custom - Specify in inches (IE: CU4.5)	XX No EMB or Customization EMB7 7 Watt battery back-up** (Approximately 600 lumens) EMB12 12 Watt battery back-up** (Approximately 1,000 lumens) 90 90+ CRI LED BOARDS (2700K - 4000K only) CCP Corners/patterns* CD Custom Driver* CR Customization Requested* WSN Night Air WSE Enlighted WSW Wavelinx WSL Lutron Vive

NOTE: MF option is strongly recommended. Other options will result in higher costs and potentially longer lead times.
 **Hardware* refers to the end caps and knuckles (knuckles only for the "Rotational" option).

*Consult factory for all custom options or custom concept requests.
 NOTE: Customization may incur higher costs and/or increased lead times.
 **The EMB12 is slightly more expensive than the EMB7 option (BOTH OPTIONS ARE INTEGRAL).

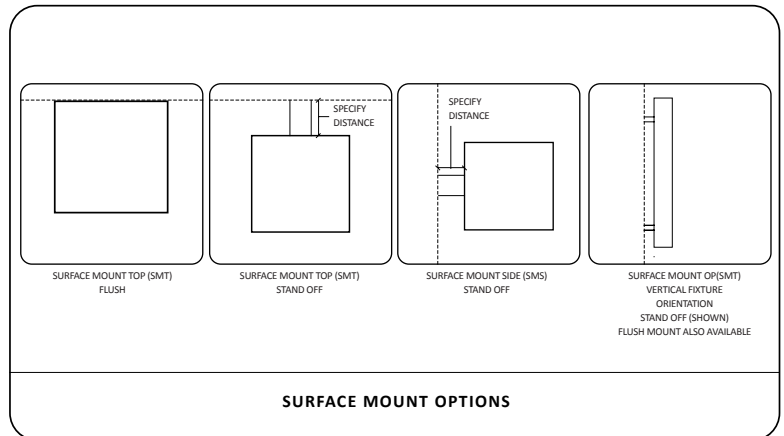

SPECIFICATION INFORMATION

NOTE: All options *italicized in gray* may increase lead times and/or incur higher costs - please consult factory with questions.

GENERAL NOTES:

All fixtures are **UL listed** for **dry** and **damp** locations.
INTEGRAL DRIVER for all options.
 Please contact the factory with any specification questions.

DRIVER: [INTEGRAL]

- 1) NON-DIMMING: As described... this fixture will not dim.
- 2) DIMMING: 0-10v: 1%, 10% :: Lutron: 2-wire Forward phase (Hi-Lume 1%), Ecosystem to 1% (Soft On), Ecosystem to 5% (5 Series). "DALI" - Specify driver. See "Dimming Options" on subsequent pages for more information. For other dimming options, consult the factory.
- 3) EMERGENCY: Specify EMB under the Options/Customization category at the end of the cut sheet along with the desired lumen output (600 or 1,000 lumens - the latter is slightly more costly).
- 4) Drivers are programmed according to our standard lumen packages or to custom watt/lumen package requirements.
- 5) Consult factory with any questions or specification requirements.

FINISHES:

The standard finish is a Satin Clear anodized housing with Machine Finished hardware. Machined finish is preferable for machined components (Hardware Detail) - Powder coating these parts may result in additional costs. Consult the factory with any questions about standard or custom finishing options.

CUSTOMIZATION:

We have numerous custom options available. However, if there is something unique required for a project, from simple options to complete custom requests, we are more than willing to entertain any creative notions you might have. Just ask.



LED COMPONENT INFORMATION

- Fixture delivered light potential: 99 Lumens/Watt*
- Uniform light distribution
- 90+ CRI LED diode options
- Exceptional binning- less than 2 step MacAdams Elipse
- Minimum 70% initial lumen output at 70,000 hours
- Standard 0-10v dimming to %10
- Lutron, Eldoled, Dali, and other dimming options
- 5 year system warranty

*Actual fixture efficacy will be dependent on specification. Higher lumens per watt are achieved with lower drive powers. Please contact the factory with questions or for more information.

LUMEN OUTPUT*

DRIVER OUTPUT	LUMEN OUTPUT (PER FOOT)	
	WATTAGE	LUMENS
VERY LOW (VLO)	4	390
LOW (LO)	6	590
STANDARD (SO)	8	775
HIGH (HO)	10	970
VERY HIGH (VHO)	12	1,130
DUAL HIGH (DHO)	19.5	1,945

DRIVER OUTPUT	PER 4' FIXTURE (TOTAL DELIVERED LUMENS)	
	WATTAGE	LUMENS
VERY LOW (VLO)	16	1,560
LOW (LO)	24	2,360
STANDARD (SO)	32	3,100
HIGH (HO)	40	3,880
VERY HIGH (VHO)	48	4,520
DUAL HIGH (DHO)	82	7,780

- **VERY LOW:** Considerably underdrives the LEDs to maximize fixture efficacy potential and limit wattage use.
- **LOW:** Underdrives the LEDs for reasonable light output while maintaining low wattage use.
- **STANDARD:** Drives the LEDs for the best combination of lumen output and fixture efficacy.
- **HIGH:** Drive the LEDs at higher capacity for higher lumen output with good efficacy.
- **VERY HIGH:** Drives the LEDs at the highest capacity for the highest lumen output with the best efficacy.

*Lumen output will vary depending on ambient temperature. Cooler ambient and LED color temperatures result in higher luminaire performance. Calculations are based on 4000K LEDs.

LUMINOUS INTENSITY DISTRIBUTION

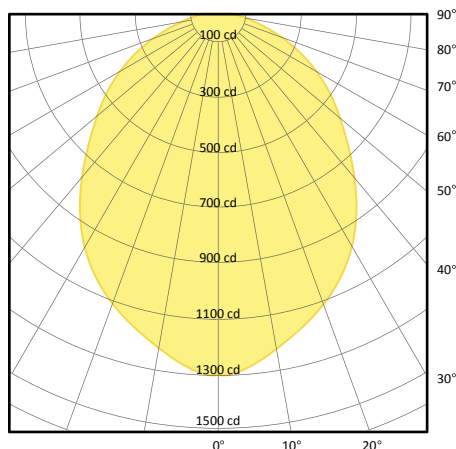

FIXTURE PROPERTIES (AS TESTED)

- 4' nominal length fixture
- Standard Output (SO)
- Total system energy consumption: 32 Watt
- 99 Lumens/Watt
- 4000K 80 CRI LED

ZONAL LUMEN SUMMARY

ZONE	LUMEN	%LAMP	%FIXTURE
0 - 30	945	21.9%	30.4%
0 - 40	1,509	34.9%	48.6%
0 - 60	2,528	58.5%	81.4%
0 - 90	3,105	71.9%	100%

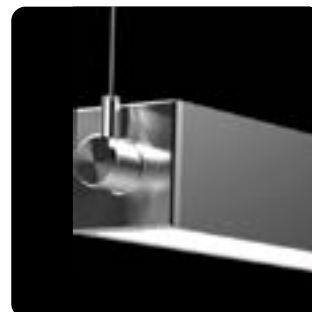

OPTIONS GUIDE

MOUNTING



CABLE SUSPENDED (CS)

3/64" aircraft cable suspension system. Nitrogen 3 (N3) can be static down-light: Direct (CSD), static up-light: Indirect (CSI), or Rotational (see below). Standard and custom power cord finishes, sleeve options, and canopy colors offer options to match almost any space. Stainless steel cables come in various lengths (4' is standard) and are field adjustable.

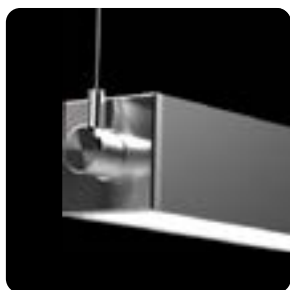

(360 DEGREE ROTATION)

CABLE SUSPENDED ROTATIONAL (CS-R)

Using a similar setup to the Cable Suspended system above, the Cable Suspended - Rotational system has 360 degree rotational capacity with mechanical fasteners to lock fixtures in place if desired. This system offers incredible flexibility, light direction control, and a dynamic aesthetic.



(360 DEGREE ROTATION)

ROTATIONAL ARM MOUNT (RAM)

This system uses 5/8" diameter aluminum arms and subtle details in combination with a 360 degree rotational capacity to create some of the most versatile linear fixtures in the architectural market. Standard mounting uses 3-O mud rings (supplied by others) or a 1" optional trim ring for furniture mounted applications. Engineered with no visible fasteners, smooth rotation, and mechanical locking, the RAM system reveals an impressive aesthetic with exceptional versatility.



(STAND-OFF)

SURFACE MOUNT (SM)

Side Mount Side (SMS) or Side Mount Top (SMT). Side, the fixture is mounted on the wall. Top, the fixture is mounted on the ceiling. Both Side and Top give a static down-light. Top or Side Mount specification denotes the power feed location(s). Optional stand-offs allows for fixtures to be mounted from 1/2" to 12" as well as custom lengths if needed.



OPTIONS GUIDE

CONTINUOUS RUN

Continuous runs are available with all fixtures and have several connection options. Single Seam continuous run options offer smooth section transitions while Component Seams lend to a more dramatic visual statement. The 360 Rotational option enables individual sections to rotate independently of each other, which offers adjustable asymmetric light distribution capacity along with striking appearances such as alternating up/down fixtures or spiral transitions. The flexibility within the rotational option makes for infinite design and functional possibilities.



CONTINUOUS RUN
SINGLE SEAM



CONTINUOUS RUN
ROTATIONAL
(SPIRAL EFFECT)



CONTINUOUS RUN
ROTATIONAL

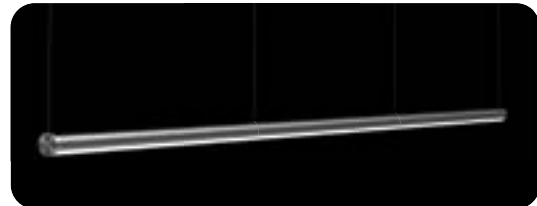

OXYGEN 2 (O2) WITH A SINGLE SEAM CONTINUOUS RUN

CANOPIES

STANDARD

Canopies have several standard options to suit various environment aesthetics. The standard cable suspension system has 5" Satin White canopies. However, other standard options include a 2" non-power feed canopy option as well as no canopy at all. Both of these include a 5" diameter power feed canopy.

55



5" diameter power feed and 5" diameter non-pow feed canopy. Most common canopy layout. Creates a consistent ceiling aesthetic.

52



5" diameter power feed and 2" diameter non-power feed canopy. Offers a more minimal ceiling treatment while maintaining the ability to cover up mistakes. Requires a 1/4-20 stud securely fastened to the ceiling.

50



5" diameter power feed canopy and no canopy on the non-power feed side. Minimal aesthetic. Requires a 1/4-20 stud securely attached to ceiling. Works well with continuous runs where the power can be carried inside the fixture.

MACHINED

Machined canopies are 4" in diameter and can be anodized as well as powder coated to match a desired color or they can be left with a mill finish for a more striking look. Similar non-power feed options are available with this aesthetic as well. These options do carry a higher cost than standard canopies, but also have an impressive appearance.

44



4" diameter machined power feed and 4" diameter machined non-power feed canopy. Offers a consistent ceiling aesthetic with smaller machined canopies. Mill, anodized, and powder coat finishes available.

41



4" diameter machined power feed and 1-1/4" diameter machined non-power feed canopy. Offers minimal ceiling treatment while maintaining the ability to cover mistakes. Requires a 1/4-20 stud securely fastened to the ceiling. Mill, anodized, and powder coat finishes available.

40



4" diameter machined power feed canopy and no canopy on the non-power feed side. Minimal aesthetic. Requires a 1/4-20 stud securely attached to the ceiling. Works well with continuous runs where the power can be carried inside the fixture. Mill, anodized, and powder coat finishes available.

CUSTOM

Custom canopy options are available and can look spectacular in certain applications. Contact the factory with all custom requests or with any questions.



CUSTOM POWDER COAT



CUSTOM ANODIZE



CUSTOM SHAPE



Lumium Lighting, LLC | 3590 Cadillac Ave, Suite A, Costa Mesa, CA 92626 | Phone: 760.757.2530 | Fax: 760.283.2333 | www.lumiumlighting.com

While we always strive to ensure all website content and product information is current, Lumium Lighting reserves the right to change specifications without notice.
© Lumium Lighting, LLC - All rights reserved.



Lumium
lighting at its element

OPTIONS GUIDE

COLOR AND FINISH

Standard finish configurations are Satin Clear (SC) housing with Machined Finish (MF) machined components (end caps, knuckles, cover plates, etc.). The incredibly clean detail within all of the machined components leads to an incredibly high end aesthetic with two tone finish. Numerous custom anodizing and powder coated finishes are available as well. If you have a particular color/finish treatment in mind, please contact the factory and we will do our best to accommodate your project needs.

STANDARD





SATIN CLEAR ANODIZING





MACHINED COMPONENTS

CUSTOM



BLACK



GLOSS BLACK



BRONZE



MILL ALUMINUM



SPECULAR

WHITE



GLOSS WHITE

COLOR POWDER COAT

COLOR ANODIZE

RAL COLORS

FINISHED CONFIGURATION



THALLIUM 2 (Th2)

Cable Suspended Rotational mount system with two-tone finish, Satin Clear housing and Machined Finish components.

COVER PLATES

Cover plates are standard for Rotational Arm Mounting (RAM) Systems. Standard options are Flat (FT), Curved (CV), or Trim Ring (TR). With certain applications, cover plates or trim rings may not be necessary. Contact factory with questions or for more information. Custom cover plates are also available. If a certain aesthetic is desired, please contact the factory to review any concepts and we will do our best to bring your vision to life.

STANDARD

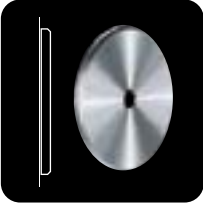

FLAT (CPFT)

Flat has a 4" diameter cover plate for use with a 3-O mud ring.

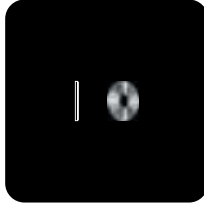

TRIM RING (TR)

1-1/4" diameter trim ring Can be used in applications such as desk mounting.

CUSTOM

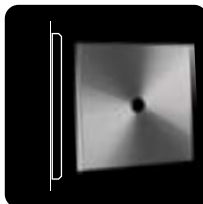

SQUARE

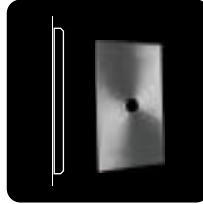

TALL RECTANGLE



CUSTOM

CUSTOM