

NEODYMIUM 2

OVERVIEW • SPECIFICATIONS • ORDERING

CABLE SUSPENDED CS

DATE	PROJECT	FIRM	TYPE
------	---------	------	------

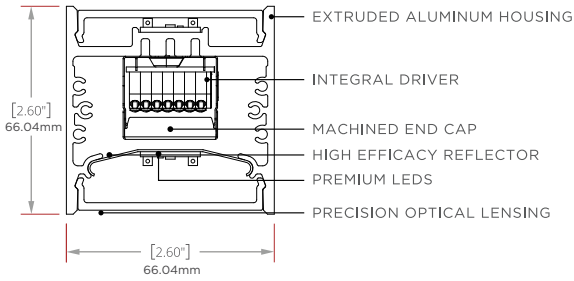

PERFORMANCE

STATIC WHITE | FLOOD DIRECT & FLOOD INDIRECT

POWER LEVELS	LIGHT DIRECT LM/4FT	LIGHT INDIRECT LM/4FT	TOTAL LIGHT LM/4FT	ENERGY WATTS/4FT	EFFICACY LPW	CCT/CRI
VL	2115	2323	4438	32	139	4000/80
L	2964	3256	6220	48	130	4000/80
S	3925	4311	8235	64	129	4000/80
H	4722	5187	9909	80	124	4000/80
VH	5696	6256	11953	96	125	4000/80



FEATURES:

- PRECISION OPTICAL LENSING OPTIONS OR HIGH TRANSMISSION FROSTED LENSING
- 1% DIMMING DRIVERS STANDARD
- ADJUSTABLE AIRCRAFT CABLE SUSPENSION SYSTEM
- EXTRUDED ALUMINUM HOUSING WITH NO VISIBLE FASTENERS
- MACHINED ALUMINUM END CAPS WITH EASY ACCESS REMOVAL
- 360 DEGREE ROTATION OPTION WITH MECHANICAL LOCKING
- BI-DIRECTIONAL FIXTURE
- UGR<19 IN SELECT OUTPUTS AND CONFIGURATIONS

CCT MULTIPLIERS STATIC WHITE

CCT	2700K		3000K		3500K		4000K		5000K	
CRI	80	90	80	90	80	90	80	90	80	90
MULTIPLIER	0.93	0.79	0.96	0.82	0.97	0.85	1	0.89	1.01	0.89



NOTE: ALL ITALICIZED OPTIONS MAY INCREASE LEAD TIME. PLEASE CONSULT FACTORY WITH QUESTIONS.

FIXTURE MODEL	MOUNTING	NOMINAL LENGTH (FT)	CCT/CRI	DIRECT POWER LEVEL ¹	DIRECT BEAM DISTRIBUTION	INDIRECT POWER LEVEL ¹	INDIRECT BEAM DISTRIBUTION ¹	DRIVER
ND2 Neodymium 2	CS Cable Suspended CSR Cable Suspended Rotational	2	827	VL	Very low	G	Graze	1D 0-10V EidoLED 1% 01D 0-10V EidoLED 0.1% LDE1 Lutron Ecosystem 1% LDES Lutron Ecosystem 5% 1DT (TW) ² 1DW (WD) ² DMX8 Standard 8 bit (RGBW) [*] DMX16 Optional 16 bit (RGBW) [*] DALI (INTL) TWS (Sensor Fixtures) ³
		3	830	L	Low	N	Narrow	
		4	835	S	Standard		Flood	
		5	840	H	High	F	Flood	
		6	850	VH	Very High	W	Wall Wash	
		7	927		A	Aisle		
		8	930					
		CP ^{3,4}	Custom Pattern					
CR ^{1,2}	Continuous Run (Specify Length in Nominal Feet)	935 940 950	TW2765 WD1827 RGBW ¹	1. 2ft & 3ft - must have same power output for up and down	1. 2ft & 3ft - must have same power output for up and down	1. Driver must reside in remote housing 2. 0-10V input - CHOOSE DALI instead for INTL versions 3. Integrated Sensor options pair with TWS driver only		

HOUSING FINISH	END CAPS FINISH ¹	CANOPY SIZE	CANOPY FINSH	POWER CORD	CABLE LENGTH	OPTIONS ⁶
SC Satin Clear Anodize SW Satin White Powder Coat MB Matte Black Powder Coat CF Custom Finish (Consult Factory)	MF Machined Finish SW Satin White MB Matte Black CF Custom Finish (Consult Factory)	44 4" Power feed canopy 4" Non-power feed canopy 44E 4" Power feed canopy 4" Non-power feed canopy - International 40 4" Power feed canopy Canopy only at power feed 40E 4" Power feed canopy Canopy only at power feed - International 41 4" Power feed canopy 1" Non-power feed canopy 41E 4" Power feed canopy 1" Non-power feed canopy - International	MF Machine Finish SW Satin White MB Matte Black CF Custom Finish (Consult Factory)	W White B Black G Gray ¹	4 4' 8 8'	EMB7 ^{1,3,5,6} 7 Watt battery back-up (Approximately 600 lumens) EMB12 ^{1,4,5,6} 12 Watt battery back-up (Approximately 1000 lumens) EMW ^{1,2} Emergency Circuit Wiring WSN ⁶ WSN nLight sensor WSE ⁶ WSE Enlighted Sensor WSW ⁶ WSW Wavelinx Sensor WSL ⁶ WSL Lutron Vive Sensor Dual Dual Circuit 1. EMB/EMW only linked to first section of continuous run 2. EMW not available for 2ft/3ft lengths 3. EMB7 - 6ft and up 4. EMB12 - 7ft and up 5. EMB not available for combined 8ft length & VH power 6. Factory EMB and Sensor (WS) options not avail for INTL

GENERAL NOTES:

All fixtures are UL listed for dry and damp locations. Fixtures with International (E) option designation are CE and ROHS compliant. INTEGRAL DRIVER for all options. Please contact the factory with any specification questions.



FIXTURE ORIENTATION

Bidirectional (CS) for downlight and uplight applications. Rotational (CSR) for adjustable applications: 360 degree rotational capacity with locking mechanism

ECOSENSE[®]

ECOSENSE LIGHTING INC.
837 NORTH SPRING STREET
SUITE 103
LOS ANGELES, CA 90012

P • 310.496.6255
F • 310.496.6256
T • 855.632.6736
855.6.ECOSEN

SPECIFICATIONS SUBJECT TO CHANGE WITHOUT NOTICE. VISIT ECOSENSELIGHTING.COM FOR THE MOST CURRENT SPECIFICATIONS. FOR A LIST OF PATENTS VISIT ECOSENSELIGHTING.COM/IP-PORTFOLIO/.
©2019 ECOSENSE LIGHTING INC. ALL RIGHTS RESERVED. ECOSENSE, THE ECOSENSE LOGO, TROV, TROV AND ECOSPEC ARE REGISTERED TRADEMARKS OF ECOSENSE LIGHTING INC.
RISE™, SLIM COVE™, FREEDOM TO CREATE™, MACRO™, FLIP-TO-FLAT™ ARE TRADEMARKS OF ECOSENSE LIGHTING INC.

NEODYMIUM 2

OVERVIEW • SPECIFICATIONS • ORDERING

ROTATIONAL ARM MOUNT

DATE	PROJECT	FIRM	TYPE
------	---------	------	------

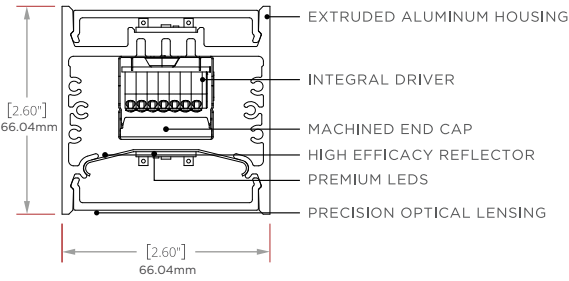

FEATURES:

- 3/4" DIAMETER RIGID TUBE MOUNTING SYSTEM
- PRECISION OPTICAL LENSING OPTIONS OR HIGH TRANSMISSION FROSTED LENSING
- 1% DIMMING DRIVERS STANDARD
- EXTRUDED ALUMINUM HOUSING WITH NO VISIBLE FASTENERS
- MACHINED ALUMINUM END CAPS WITH EASY ACCESS REMOVAL
- 360 DEGREE ROTATION OPTION WITH MECHANICAL LOCKING

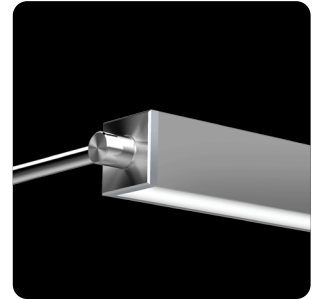

NOTE: ALL ITALICIZED OPTIONS MAY INCREASE LEAD TIME. PLEASE CONSULT FACTORY WITH QUESTIONS.

FIXTURE MODEL	MOUNTING	NOMINAL LENGTH (FT)	CCT/CRI	DIRECT POWER LEVEL ¹	DIRECT BEAM DISTRIBUTION	INDIRECT POWER LEVEL ¹	INDIRECT BEAM DISTRIBUTION ¹	DRIVER
ND2 Neodymium 2	RAM Rotational Arm Mount <i>RAME</i> Rotational Arm Mount - International	2	827 830 835 840 850 927 930 935 940 950 <i>TW2765</i> <i>WD1827</i> <i>RGBW</i> <i>1% only w/</i> <i>power level(s)</i> = S, beams = F	VL Very low L Low S Standard H High VH Very High	G Graze N Narrow F Flood W Wall Wash A Aisle	VL Very low L Low S Standard H High VH Very High	F Flood B Batwing	1D 0-10V EldoLED 1% 01D 0-10V EldoLED 0.1% <i>LDE1</i> Lutron Ecosystem 1% <i>LDES</i> Lutron Ecosystem 5% 1DT (TW) ² 1DW (WD) ² DMX8 Standard 8 bit (RGBW) [*] DMX16 Optional 16 bit (RGBW) [*] DALI (INTL) TWS (Sensor Fixtures) ³ 1. Driver must reside in remote housing 2. 0-10V input - CHOOSE DALI instead for INTL versions 3. Integrated Sensor options pair with TWS driver only
		3						
		4						
		5						
		6						
		7						
		8						
		CR1 ² Continuous Run (Specify Length in Nominal Feet)						
		1. Power feed is always at the first section in a continuous run 2. Rotational mounting w/ CR will have a power feed for every section						
		1.2ft & 3ft - must have same power output for up and down						

HOUSING FINISH	END CAPS & RAM HARDWARE FINISH	ARM LENGTH NOM (IN)	MOUNTING PLATE	OPTIONS ⁶
SC Satin Clear Anodize SW Satin White Powder Coat MB Matte Black Powder Coat CF Custom Finish (Consult Factory)	MF Machined Finish SW Satin White MB Matte Black CF Custom Finish (Consult Factory)	3 6' 9' 12'	4CPF	EMB7 ^{1,3,5,6} 7 Watt battery back-up (Approximately 600 lumens) EMB12 ^{1,4,5,6} 12 Watt battery back-up (Approximately 1000 lumens) EMW ^{1,2} Emergency Circuit Wiring <i>WSN</i> ⁵ WSN nLight sensor <i>WSE</i> ⁵ WSE Englighted Sensor <i>WSW</i> ⁵ WSW Wavelinx Sensor <i>WSL</i> ⁵ WSL Lutron Vive Sensor <i>Dual Circuit</i>
		1. Includes Mounting Tieback		1. EMB/EMW only linked to first section of continuous run 2. EMW not available for 2ft/3ft lengths 3. EMB7 - 6ft and up 4. EMB12 - 7ft and up 5. EMB not available for combined 8FT length & VH power 6. Factory EMB and Sensor (WS*) options not avail for INTL

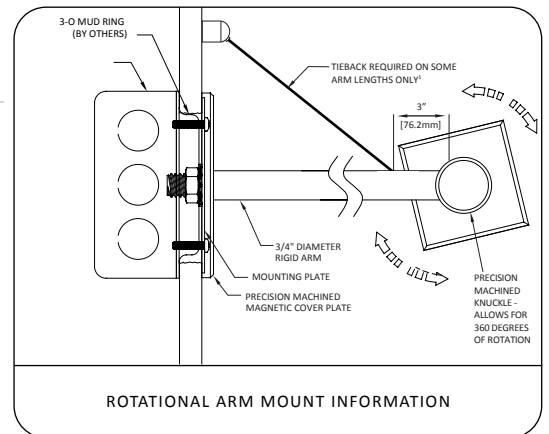

GENERAL NOTES:

All fixtures are UL listed for dry and damp locations. Fixtures with International (E) option designation are CE and ROHS compliant. INTEGRAL DRIVER for all options. Please contact the factory with any specification questions.



ECOSENSE

ECOSENSE LIGHTING INC.
837 NORTH SPRING STREET
SUITE 103
LOS ANGELES, CA 90012

P • 310.496.6255
F • 310.496.6256
T • 855.632.6736
855.6.ECOSEN

SPECIFICATIONS SUBJECT TO CHANGE WITHOUT NOTICE. VISIT ECOSENSELIGHTING.COM FOR THE MOST CURRENT SPECIFICATIONS. FOR A LIST OF PATENTS VISIT ECOSENSELIGHTING.COM/IP-PORTFOLIO/. ©2019 ECOSENSE LIGHTING INC. ALL RIGHTS RESERVED. ECOSENSE, THE ECOSENSE LOGO, TRUV, TROV AND ECOSPEC ARE REGISTERED TRADEMARKS OF ECOSENSE LIGHTING INC. RISE™, SLIM COVE™, FREEDOM TO CREATE™, MACRO™, FLIP-TO-FLAT™ ARE TRADEMARKS OF ECOSENSE LIGHTING INC.

NEODYMIUM 2

OVERVIEW • SPECIFICATIONS • ORDERING

SURFACE MOUNT (SM)

DATE	PROJECT	FIRM	TYPE
------	---------	------	------

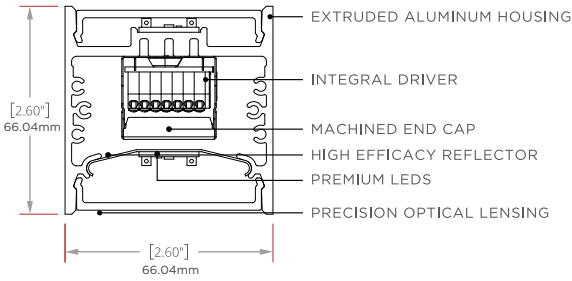

FEATURES:

- WALL MOUNTING SYSTEM WITH PRE LOCATED FIXTURE HARDWARE FOR EASY SURFACE INSTALL
- PRECISION OPTICAL LENSING OPTIONS OR HIGH TRANSMISSION FROSTED LENSING
- 1% DIMMING DRIVERS STANDARD
- EXTRUDED ALUMINUM HOUSING WITH NO VISIBLE FASTENERS
- MACHINED ALUMINUM END CAPS WITH EASY ACCESS REMOVAL

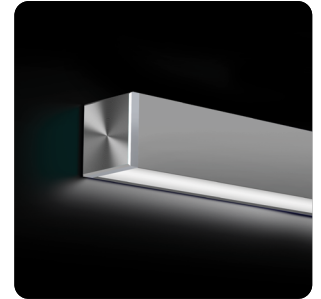

NOTE: ALL ITALICIZED OPTIONS MAY INCREASE LEAD TIME. PLEASE CONSULT FACTORY WITH QUESTIONS.

FIXTURE MODEL	MOUNTING	NOMINAL LENGTH (FT)	CCT/CRI	DIRECT POWER LEVEL ¹	DIRECT BEAM DISTRIBUTION	INDIRECT POWER LEVEL ¹	INDIRECT BEAM DISTRIBUTION
ND2 Neodymium 2	SMS Surface Mount Side <i>SMSE</i> Surface Mount Side - International	2	827	VL Very low	G Graze	VL Very low	F Flood
		3	830	L Low	N Narrow	L Low	B Batwing
		4	835	S Standard	F Flood	S Standard	
		5	840	H High	F Flood	H High	
		6	850	VH Very High	W Wall Wash	VH Very High	
		7	927		A Aisle		
		8	930				
		CR ¹ Continuous Run (Specify Length in Nominal Feet)	935				
			940				
			950				
	<i>TW2765</i>						
	<i>WD1827</i>						
	<i>RGBW¹</i>						
	1. Power feed is always first section of a continuous run		1. Pair only w/ power level(s) = S, beams = F	1. 2ft & 3ft - must have same power output for up and down		1. 2ft & 3ft - must have same power output for up and down	

DRIVER	HOUSING FINISH	END CAPS FINISH	OPTIONS ⁶
1D 0-10V EldoLED 1% <i>01D</i> 0-10V EldoLED 0.1% <i>LDE1</i> Lutron Ecosystem 1% <i>LDE5</i> Lutron Ecosystem 5% 1DT (TW) ² 1DW (WD) ² DMX8 Standard 8 bit (RGBW)* DMX16 Optional 16 bit (RGBW)* DALI (INTL) TWS (Sensor Fixtures) ³	SC Satin Clear Anodize SW Satin White Powder Coat MB Matte Black Powder Coat CF Custom Finish (Consult Factory)	MF Machined Finish SW Satin White MB Matte Black CF Custom Finish (Consult Factory)	EMB7 ^{1,3,5,6} 7 Watt battery back-up (Approximately 600 lumens) EMB12 ^{1,4,5,6} 12 Watt battery back-up (Approximately 1000 lumens) EMW ^{1,2} Emergency Circuit Wiring <i>WSN</i> ⁶ WSN nLight Sensor <i>WSE</i> ⁶ WSE Enlightened Sensor <i>WSW</i> ⁶ WSW Wavelength Sensor <i>WSL</i> ⁶ WSL Lutron Vive Sensor Dual Circuit Dual Circuit
1. Driver must reside in remote housing 2. 0-10V input - CHOOSE DALI instead for INTL versions 3. Integrated Sensor options pair with TWS driver only			1. EMB/EMW only linked to first section of continuous run 2. EMW not available for 2ft/3ft lengths 3. EMB7 - 6ft lengths and up 4. EMB12 - 7ft and up 5. EMB not available for combined 8FT length & VH power 6. Factory EMB and Sensor (WS*) options not avail for INTL

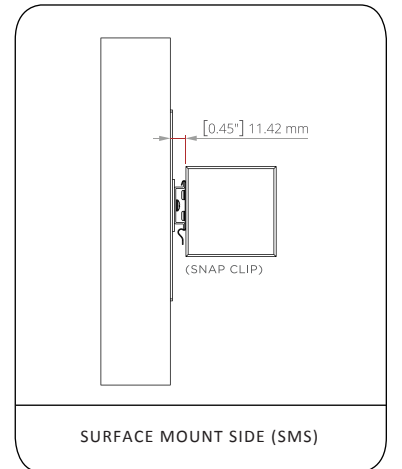

GENERAL

All fixtures are UL listed for dry and damp locations. Fixtures with International (E) option designation are CE and ROHS compliant INTEGRAL DRIVER for all options. Please contact the factory with any specification questions.



ECOSENSE

ECOSENSE LIGHTING INC.
 837 NORTH SPRING STREET
 SUITE 103
 LOS ANGELES, CA 90012

P • 310.496.6255
F • 310.496.6256
T • 855.632.6736
 855.6.ECOSEN

SPECIFICATIONS SUBJECT TO CHANGE WITHOUT NOTICE. VISIT ECOSENSELIGHTING.COM FOR THE MOST CURRENT SPECIFICATIONS. FOR A LIST OF PATENTS VISIT ECOSENSELIGHTING.COM/IP-PORTFOLIO/. ©2019 ECOSENSE LIGHTING INC. ALL RIGHTS RESERVED. ECOSENSE, THE ECOSENSE LOGO, TROV, TROV AND ECOSPEC ARE REGISTERED TRADEMARKS OF ECOSENSE LIGHTING INC. RISE™, SLIM COVE™, FREEDOM TO CREATE™, MACRO™, FLIP-TO-FLAT™ ARE TRADEMARKS OF ECOSENSE LIGHTING INC.

NEODYMIUM 2

OVERVIEW • SPECIFICATIONS • ORDERING

PHOTOMETRIC DATA

DATE	PROJECT	FIRM	TYPE
------	---------	------	------

BIDIRECTIONAL

STATIC WHITE | FLOOD DIRECT & FLOOD INDIRECT

POWER LEVELS	LIGHT DIRECT LM/4FT	LIGHT INDIRECT LM/4FT	TOTAL LIGHT LM/4FT	ENERGY WATTS/4FT	EFFICACY LPW	CCT/CRI
VL	2115	2323	4438	32	139	4000/80
L	2964	3256	6220	48	130	4000/80
S	3925	4311	8235	64	129	4000/80
H	4722	5187	9909	80	124	4000/80
VH	5696	6256	11953	96	125	4000/80

CCT MULTIPLIERS, STATIC WH

CCT	80CRI	90CRI
2700K	0.93	0.79
3000K	0.96	0.82
3500K	0.97	0.85
4000K	1.00	0.89
5000K	1.01	0.89

DYNAMIC WHITE | FLOOD DIRECT & FLOOD INDIRECT

POWER LEVELS	LIGHT DIRECT LM/4FT	LIGHT INDIRECT LM/4FT	TOTAL LIGHT LM/4FT	ENERGY WATTS/4FT	EFFICACY LPW	CCT
VL	1484	1630	3115	48	65	4000/90
L	2081	2285	4366	64	68	4000/90
S	2755	3025	5780	72	80	4000/90
H	3314	3640	6955	88	79	4000/90
VH	3998	4391	8389	96	87	4000/90

CCT MULTIPLIERS, DYNAMIC WH

CCT	90CRI
2700K	1.09
3000K	1.08
3500K	1.03
4000K	1.00
5000K	0.99
6500K	0.98

WARM DIM | FLOOD DIRECT & FLOOD INDIRECT

POWER LEVELS	LIGHT DIRECT LM/4FT	LIGHT INDIRECT LM/4FT	TOTAL LIGHT LM/4FT	ENERGY WATTS/4FT	EFFICACY LPW	CCT
VL	1558	1712	3270	48	68	2700/90
L	2184	2399	4584	64	72	2700/90
S	2892	3176	6068	72	84	2700/90
H	3480	3822	7302	88	83	2700/90
VH	4197	4610	8808	96	92	2700/90

CCT MULTIPLIERS, WARM DIM

CCT	90CRI
1800K	0.02
2250K	0.17
2700K	1.00

RGBW | FLOOD DIRECT & FLOOD INDIRECT

POWER LEVELS	CHANNEL (S)	LIGHT DIRECT LM/4FT	LIGHT INDIRECT LM/4FT	TOTAL LIGHT LM/4FT	ENERGY WATTS/4FT	EFFICACY LPW	CCT
S	White	382	420	802	20	40	4000
S	All	883	970	1853	40	46	N/A



ECOSENSE LIGHTING INC.
837 NORTH SPRING STREET
SUITE 103
LOS ANGELES, CA 90012

P • 310.496.6255
F • 310.496.6256
T • 855.632.6736
855.6.ECOSEN

SPECIFICATIONS SUBJECT TO CHANGE WITHOUT NOTICE. VISIT ECOSENSELIGHTING.COM FOR THE MOST CURRENT SPECIFICATIONS. FOR A LIST OF PATENTS VISIT ECOSENSELIGHTING.COM/IP-PORTFOLIO/. ©2019 ECOSENSE LIGHTING INC. ALL RIGHTS RESERVED. ECOSENSE, THE ECOSENSE LOGO, TROV, TROV AND ECOSPEC ARE REGISTERED TRADEMARKS OF ECOSENSE LIGHTING INC. RISE™, SLIM COVE™, FREEDOM TO CREATE™, MACRO™, FLIP-TO-FLAT™ ARE TRADEMARKS OF ECOSENSE LIGHTING INC.

NEODYMIUM 2

OVERVIEW • SPECIFICATIONS • ORDERING

PHOTOMETRIC DATA

DATE	PROJECT	FIRM	TYPE
------	---------	------	------

DIRECT

DIRECT OPTICS: LUMEN OUTPUT (PER 4FT)

TYPE	CCT/CRI	ENERGY WATTS/4FT	FLOOD LM/4FT	FLOOD LPW	NARROW FLOOD LM/4FT	NARROW FLOOD LPW	AISLE LIGHTER LM/4FT	AISLE LIGHTER LPW	GRAZE LM/4FT	GRAZE LPW	WALL WASH LM/4FT	WALL WASH LPW
STATIC WHITE	4000K/80	S (32W)	3925	123	4475	140	4446	139	4752	149	4063	127
DYNAMIC WHITE	4000K/90	S (36W)	2755	77	3138	87	3103	86	3312	92	2824	78
WARM DIM	2700K/90	S (36W)	2892	80	3295	92	3258	91	3478	97	2965	82
RGBW	ALL CHANNELS UP	S (20W)	883	44	N/A	N/A	N/A	N/A	N/A	N/A	N/A	N/A

FLOOD*

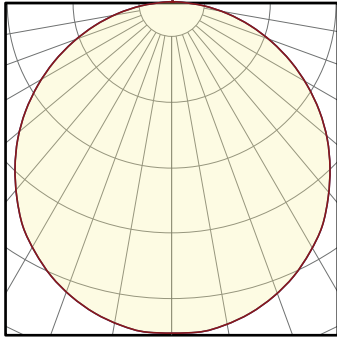

MAX CANDELA: 1336
DELIVERED LUMENS: 3925
WATTS: 32
LPW: 123

NARROW FLOOD*

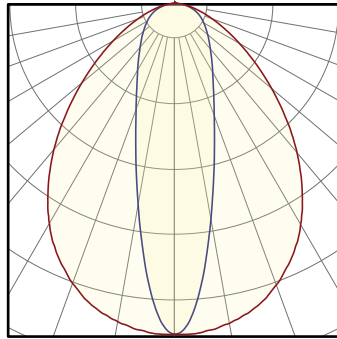

MAX CANDELA: 3831
DELIVERED LUMENS: 4475
WATTS: 32
LPW: 140

AISLE LIGHTER*

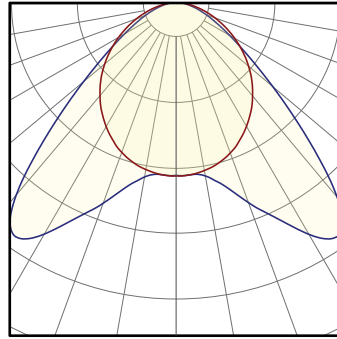

MAX CANDELA: 2061
DELIVERED LUMENS: 4446
WATTS: 32
LPW: 139

WALL GRAZE*

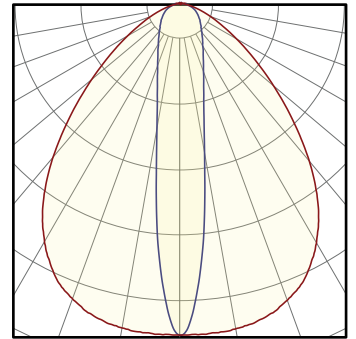

MAX CANDELA: 5197
DELIVERED LUMENS: 4752
WATTS: 32
LPW: 149

WALL WASH*

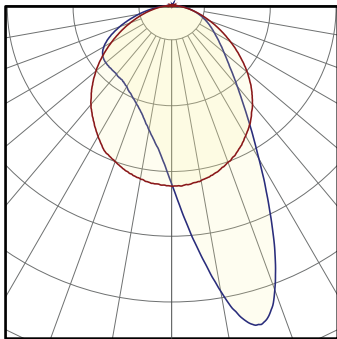

MAX CANDELA: 2973
DELIVERED LUMENS: 4063
WATTS: 32
LPW: 127

CCT MULTIPLIERS STATIC WHITE

CCT	2700K		3000K		3500K		4000K		5000K	
CRI	80	90	80	90	80	90	80	90	80	90
MULTIPLIER	0.93	0.79	0.96	0.82	0.97	0.85	1	0.89	1.01	0.89

CCT MULTIPLIERS DYNAMIC WHITE

CCT	2700K	3000K	3500K	4000K	5000K	6000K
CRI	90	90	90	90	90	90
MULTIPLIER	1.09	1.08	1.03	1	0.99	0.98

CCT MULTIPLIERS WARM DIM

CCT	1800K	2250K	2700K
CRI	90	90	90
MULTIPLIER	0.02	0.17	1

POWER LEVEL MULTIPLIERS

POWER	VL	L	S	H	VH
STATIC WHITE	0.53	0.75	1	1.2	1.45
DYNAMIC WHITE	0.53	0.75	1	1.2	1.45
WARM DIM	0.53	0.75	1	1.2	1.45

*Fixture Properties: 4ft Nominal Length, Standard Output, Static White 4000K/80CRI

DATE	PROJECT	FIRM	TYPE
------	---------	------	------

INDIRECT

INDIRECT OPTICS: LUMEN OUTPUT (PER 4FT)

TYPE	CCT/CRI	ENERGY WATTS/4FT	FLOOD LM/4FT	FLOOD LPW	BATWING LM/4FT	BATWING LPW
STATIC WHITE	4000K/80	S (32W)	4311	135	3933	123
DYNAMIC WHITE	4000K/90	S (36W)	3025	84	2764	77
WARM DIM	2700K/90	S (36W)	3176	88	2902	81
RGBW	ALL CHANNELS UP	S (20W)	970	49	N/A	N/A

FLOOD*

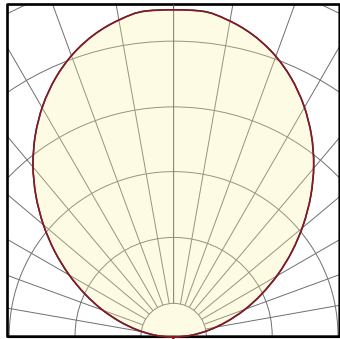

MAX CANDELA: 1677
DELIVERED LUMENS: 4311
WATTS: 32
LPW: 135

BATWING*

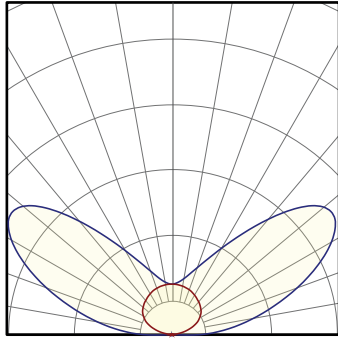

MAX CANDELA: 1722
DELIVERED LUMENS: 3933
WATTS: 32
LPW: 123

LUMINAIRE TOTAL LUMENS PER WATT

$$\frac{(\text{DIRECT LUMENS/FT} + \text{INDIRECT LUMENS/FT}) \times \text{FIXTURE TOTAL LINEAR FT}}{(\text{DIRECT WATTS/FT} + \text{INDIRECT WATTS/FT}) \times \text{FIXTURE TOTAL LINEAR FT}} = \text{TOTAL LUMINAIRE LUMENS PER WATT}$$

*Fixture Properties: 4ft Nominal Length, Standard Output, Static White 4000K/80CRI

CCT MULTIPLIERS STATIC WHITE

CCT	2700K		3000K		3500K		4000K		5000K	
CRI	80	90	80	90	80	90	80	90	80	90
MULTIPLIER	0.93	0.79	0.96	0.82	0.97	0.85	1	0.89	1.01	0.89

CCT MULTIPLIERS DYNAMIC WHITE

CCT	2700K	3000K	3500K	4000K	5000K	6000K
CRI	90	90	90	90	90	90
MULTIPLIER	1.09	1.08	1.03	1	0.99	0.98

CCT MULTIPLIERS WARM DIM

CCT	1800K	2250K	2700K
CRI	90	90	90
MULTIPLIER	0.02	0.17	1

POWER LEVEL MULTIPLIERS

POWER	VL	L	S	H	VH
STATIC WHITE	0.53	0.75	1	1.2	1.45
DYNAMIC WHITE	0.53	0.75	1	1.2	1.45
WARM DIM	0.53	0.75	1	1.2	1.45

DATE	PROJECT	FIRM	TYPE
------	---------	------	------

MOUNTING



CABLE SUSPENDED (CS)

This fixture can be a cable suspended down-light and up-light: Bi-Directional (CS), or can be special ordered as a cable suspended static down-light only: Direct Only (CSD). Aircraft cables come in 4ft and 8ft lengths and are field adjustable.

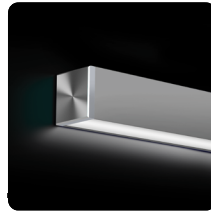

SURFACE MOUNT SIDE (SMS)

Surface Mount Side (SMS). The fixture is mounted on the wall using mounting brackets, giving a static bi-directional up-light and down-light.



CABLE SUSPENDED - ROTATIONAL (CSR)

Using a similar setup to the Cable Suspended system above, the Cable Suspended - Rotational system has 360 degree rotational capacity with mechanical fasteners to lock fixtures in place if desired. This system offers incredible flexibility, light direction control, and a dynamic aesthetic.

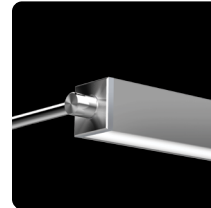

ROTATIONAL ARM MOUNT (RAM)

This system uses 5/8" diameter aluminum arms and subtle details in combination with a 360 degree rotational capacity to create some of the most versatile linear fixtures in the architectural market. Standard mounting uses 3/0 mud rings (supplied by others). Engineered with no visible fasteners, smooth rotation, and mechanical locking, the RAM system reveals an impressive aesthetic with exceptional versatility.

CONTINUOUS RUN (CR)

This fixture has two continuous run connection options. Our single seam continuous run option offers smooth transitions from one section to the next. The joiner bracket and alignment pin system in this option, offers easy to use, confident, single seam connections with a tight fit.

Alternatively, our 360 degree rotational option enables individual sections to rotate independently of each other, which offers adjustable asymmetric light distribution capacity along with striking appearances such as alternating up/down fixtures or spiral transitions. The flexibility within the rotational option makes for infinite design and functional possibilities.



FIXTURE WITH SINGLE SEAM CONTINUOUS RUN



CONTINUOUS RUN ROTATIONAL



CONTINUOUS RUN ROTATIONAL (SPIRAL EFFECT)



CONTINUOUS RUN SINGLE SEAM



FIXTURE WITH CONTINUOUS RUN ROTATIONAL

CANOPIES

44



4" diameter power feed and 4" diameter non-power feed canopy.

41

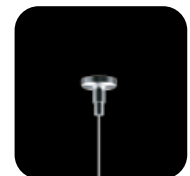

4" diameter machined power feed and 1-1/4" diameter machined non-power feed canopy. Offers minimal ceiling treatment while maintaining the ability to cover mistakes. Requires a 1/4-20 stud securely fastened to the ceiling.

40



4" diameter machined power feed canopy and no canopy on the non-power feed side. Minimal aesthetic. Requires a 1/4-20 stud securely attached to the ceiling.

44E, 41E, 40E (**E) International Canopy











INTL POWERFEED CANOPY FOR INTEGRAL DRIVER FIXTURES

This powerfeed canopy replaces the flat style canopy from the North American mounting style (44, 41, & 40) versions pictured)

DATE	PROJECT	FIRM	TYPE
------	---------	------	------

COLOR AND FINISH

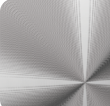
Standard luminaire housing finishes are Satin Clear anodized, Matte Black powder coat, and Satin White powder coat. Standard hardware (end caps, knuckles, cover plates, etc.) finishes are Machined Finish, Matte Black powder coat, & Satin White powder coat. Custom anodizing and powder coated finishes are available as well. If you have a particular color/finish treatment in mind, please contact the factory and we will do our best to accommodate your project needs.

STANDARD			CUSTOM			
LUMINAIRE						
						
SATIN CLEAR ANODIZING	MATTE BLACK	SATIN WHITE	BRONZE	COLOR ANODIZE	SPECULAR	RAL COLORS
HARDWARE						
						
MACHINED COMPONENTS	MATTE BLACK	SATIN WHITE				

SENSORS

Optional fixture integrated sensors and controls offer wireless control system compatibility directly from the factory. Lumium luminaires are now available with integrated control gear from 4 major partners.

			
---	---	--	---

NOTE: Information on this Spec Sheet is subject to change, please visit www.ecosenselighting.com for the most updated information.

DATE	PROJECT	FIRM	TYPE
------	---------	------	------

WELDED CORNERS

- Luminaire housing is custom mitered & welded for a clean corner appearance
- Lens is also mitered for lens-to-lens interfaces that mirror the mitered housing
- Lens is illuminated to the corner (AKA: lit corners)
- Adjustable aircraft cable suspension system
- High quality powder coated finish (anodized finishes not available with welded custom patterns).

CUSTOMER INSTRUCTIONS

- Select "CP" option in the ordering block (found in the NOMINAL LENGTH column)
 - Submit simple drawing(s) with the following info:
 - Provide number of legs of pattern
 - Length of each leg (A, B, C, D, etc)
 - Angles of corners (a1, b1, c1, d1, etc)
- For '3 dimensional' patterns, please provide side view(s) with desired angles, in addition to a top view.
 - Minimum corner angle is 30 degrees.



NITROGEN 3 CUSTOM PATTERN PICTURED

EXAMPLES:

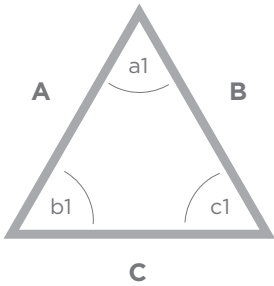

Customer Specification

- Qty Legs = 3
- A, B, C = 3ft
- a1, b1, c1 = 60 deg

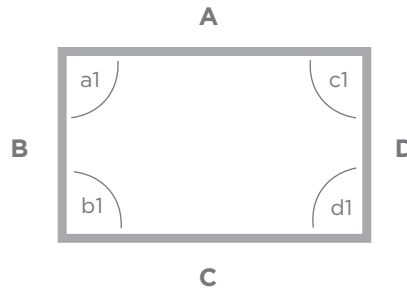

Customer Specification

- Qty Legs = 4
- A & C = 8ft, B & D = 4ft
- a1, b1, c1, d1 = 90 deg

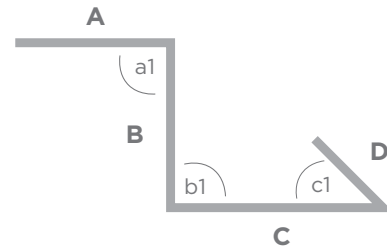

Customer Specification

- Qty Legs = 4
- A = 8ft, B = 6ft, C = 6ft, D = 4ft-3in
- a1 & b1 = 90 deg, c1 = 45 deg