

| DATE | PROJECT | FIRM | TYPE |
|------|---------|------|------|
|------|---------|------|------|

**FEATURES :**

- MODULAR OPTICS IN 20, 30, 50, & 70 DEGREE BEAM ANGLES
- UP TO 2200 LUMENS DELIVERED AT 3000K/80CRI
- 80+ LUMENS PER SYSTEM WATT
- INTEGRATED LED DRIVER FOR CLEAN AESTHETICS
- AVAILABLE IN H AND TEK TRACK OPTIONS
- WORKS WITH ELV DIMMERS

## OPTIONAL SNAP-IN DIFFUSION LENS

Interchangeable optics, no tools required



Optional Snap-in Diffusion

| DATE                                       | PROJECT  | FIRM             | TYPE   |            |      |                  |    |      |      |    |      |      |    |      |      |    |      |      |
|--|--|------------------|--|------------|------|------------------|----|------|------|----|------|------|----|------|------|----|------|------|
| <b>COLOR TEMPERATURE</b>                   | 2700K* / 3000K* / 3500K* / 4000K**   |                  | *available in 93+ CRI **available in 90+ CRI |            |      |                  |    |      |      |    |      |      |    |      |      |    |      |      |
| <b>MODULAR OPTICS</b>                      | INTERCHANGEABLE OPTIC FOR 20° / 30° / 50° / 70° BEAM ANGLE OPTIONS   |                  |  |            |      |                  |    |      |      |    |      |      |    |      |      |    |      |      |
| <b>OUTPUT AT 3000K/80CRI</b>               | <table border="1"> <thead> <tr> <th>BEAM ANGLE</th> <th>CBCP</th> <th>DELIVERED LUMENS</th> </tr> </thead> <tbody> <tr> <td>20</td> <td>8364</td> <td>2209</td> </tr> <tr> <td>30</td> <td>4298</td> <td>2269</td> </tr> <tr> <td>50</td> <td>2857</td> <td>2249</td> </tr> <tr> <td>70</td> <td>1641</td> <td>2187</td> </tr> </tbody> </table> |                  |  | BEAM ANGLE | CBCP | DELIVERED LUMENS | 20 | 8364 | 2209 | 30 | 4298 | 2269 | 50 | 2857 | 2249 | 70 | 1641 | 2187 |
| BEAM ANGLE                                 | CBCP   | DELIVERED LUMENS |  |            |      |                  |    |      |      |    |      |      |    |      |      |    |      |      |
| 20   | 8364   | 2209             |  |            |      |                  |    |      |      |    |      |      |    |      |      |    |      |      |
| 30   | 4298   | 2269             |  |            |      |                  |    |      |      |    |      |      |    |      |      |    |      |      |
| 50   | 2857   | 2249             |  |            |      |                  |    |      |      |    |      |      |    |      |      |    |      |      |
| 70   | 1641   | 2187             |  |            |      |                  |    |      |      |    |      |      |    |      |      |    |      |      |
| <b>ELECTRICAL</b>                          | <b>SYSTEM WATTS</b>  | 27.5W            |  |            |      |                  |    |      |      |    |      |      |    |      |      |    |      |      |
|  | <b>INPUT VOLTAGE</b>   | 120V Standard    |  |            |      |                  |    |      |      |    |      |      |    |      |      |    |      |      |
| <b>DIMMING</b>                             | WORKS WITH ELV DIMMERS   |                  |  |            |      |                  |    |      |      |    |      |      |    |      |      |    |      |      |
| <b>ADJUSTABLE</b>                          | 360° HORIZONTAL COVERAGE, 85° OF VERTICAL AIMING   |                  |  |            |      |                  |    |      |      |    |      |      |    |      |      |    |      |      |
| <b>ACCESSORIES</b>                         | OPTIONAL SNAP IN DIFFUSION #OPI-SOL-DF. FOR COLORED LENSES, SHAPING LENSES, & HONEYCOMB HEX LOUVER<br>- ORDER ACCESSORY AND ADDITIONAL ACCESSORY HOLDER #ACC-SOL-HLR-73.   |                  |  |            |      |                  |    |      |      |    |      |      |    |      |      |    |      |      |
| <b>FINISH</b>                              | WHITE OR BLACK POWDERCOAT  |                  |  |            |      |                  |    |      |      |    |      |      |    |      |      |    |      |      |
| <b>RATED LIFE</b>                          | 50,000 HOURS AT 70% LUMEN MAINTENANCE  |                  |  |            |      |                  |    |      |      |    |      |      |    |      |      |    |      |      |
| <b>TRACK SYSTEM</b>                        | ECOSENSE LINE VOLTAGE H TRACK OR GLOBAL 2 CIRCUIT/2 NEUTRAL TEK TRACK  |                  |  |            |      |                  |    |      |      |    |      |      |    |      |      |    |      |      |
| <b>FIXTURE RATING &amp; CERTIFICATIONS</b> | ETL FOR USA AND CANADA<br>FOR INDOOR USE ONLY  |                  |  |            |      |                  |    |      |      |    |      |      |    |      |      |    |      |      |
| <b>WARRANTY</b>                            | 5 YEARS  |                  |  |            |      |                  |    |      |      |    |      |      |    |      |      |    |      |      |

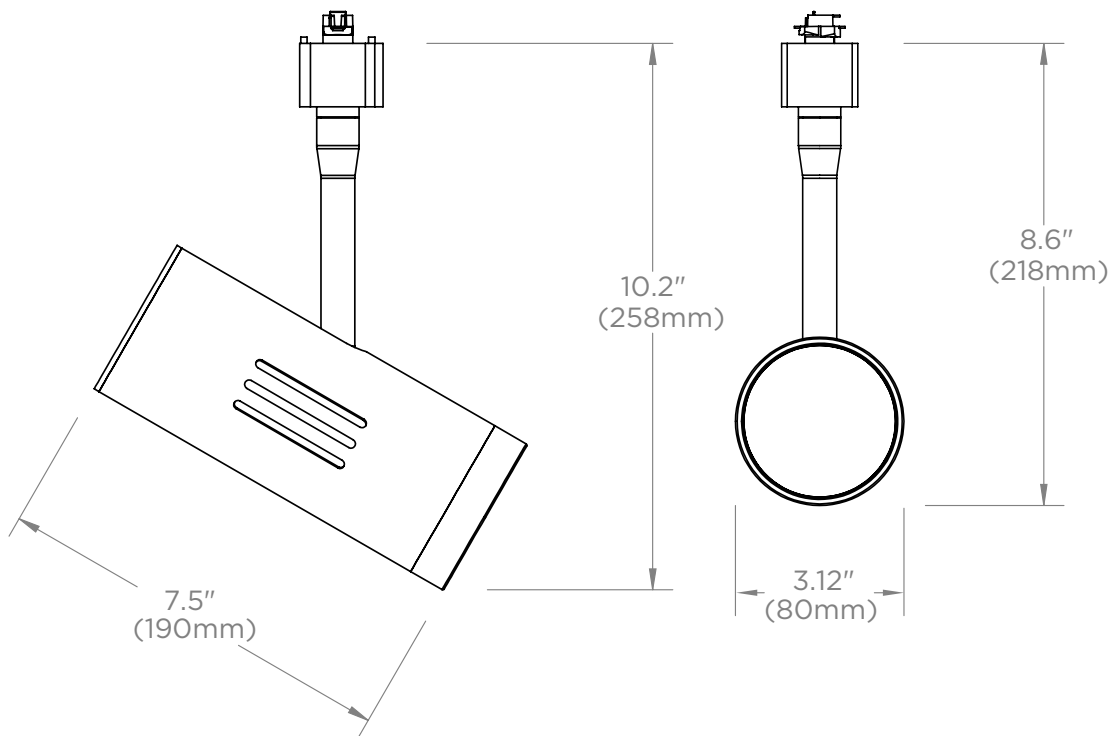

|      |         |      |      |
|------|---------|------|------|
| DATE | PROJECT | FIRM | TYPE |
|------|---------|------|------|

**ILLUMINANCE CONE DATA**

**80 CRI**  
2700K, 3000K, 3500K, 4000K

**20° CBCP: 8364**

| Distance (feet) | FC*  | Diameter (feet) |
|-----------------|------|-----------------|
| 2               | 2091 | 0.7             |
| 4               | 523  | 1.3             |
| 6               | 232  | 2.0             |
| 8               | 131  | 2.7             |
| 10              | 84   | 3.3             |
| 12              | 58   | 4.0             |



**30° CBCP: 4298**

| Distance (feet) | FC*  | Diameter (feet) |
|-----------------|------|-----------------|
| 2               | 1075 | 1.1             |
| 4               | 269  | 2.1             |
| 6               | 119  | 3.2             |
| 8               | 67   | 4.3             |
| 10              | 43   | 5.3             |
| 12              | 30   | 6.4             |



**50° CBCP: 2857**

| Distance (feet) | FC* | Diameter (feet) |
|-----------------|-----|-----------------|
| 2               | 714 | 1.8             |
| 4               | 179 | 3.6             |
| 6               | 79  | 5.3             |
| 8               | 45  | 7.1             |
| 10              | 29  | 8.9             |
| 12              | 20  | 10.7            |

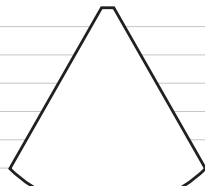

**70° CBCP: 1641**

| Distance (feet) | FC* | Diameter (feet) |
|-----------------|-----|-----------------|
| 2               | 410 | 2.7             |
| 4               | 103 | 5.3             |
| 6               | 46  | 7.9             |
| 8               | 26  | 10.6            |
| 10              | 16  | 13.2            |
| 12              | 11  | 15.9            |

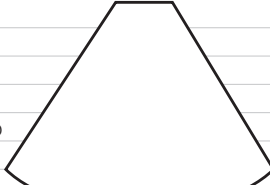

**93+ CRI**  
2700K

**20° CBCP: 6682**

| Distance (feet) | FC*  | Diameter (feet) |
|-----------------|------|-----------------|
| 2               | 5680 | 0.7             |
| 4               | 418  | 1.3             |
| 6               | 185  | 2.0             |
| 8               | 104  | 2.7             |
| 10              | 67   | 3.3             |
| 12              | 46   | 4.0             |



**30° CBCP: 3434**

| Distance (feet) | FC* | Diameter (feet) |
|-----------------|-----|-----------------|
| 2               | 859 | 1.1             |
| 4               | 215 | 2.1             |
| 6               | 95  | 3.2             |
| 8               | 54  | 4.3             |
| 10              | 35  | 5.3             |
| 12              | 24  | 6.4             |



**50° CBCP: 2282**

| Distance (feet) | FC* | Diameter (feet) |
|-----------------|-----|-----------------|
| 2               | 571 | 1.8             |
| 4               | 143 | 3.6             |
| 6               | 63  | 5.3             |
| 8               | 36  | 7.1             |
| 10              | 24  | 8.9             |
| 12              | 16  | 10.7            |

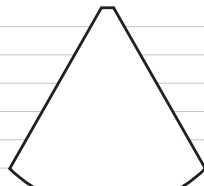

**70° CBCP: 1311**

| Distance (feet) | FC* | Diameter (feet) |
|-----------------|-----|-----------------|
| 2               | 328 | 2.7             |
| 4               | 83  | 5.3             |
| 6               | 37  | 7.9             |
| 8               | 21  | 10.6            |
| 10              | 13  | 13.2            |
| 12              | 8   | 15.9            |

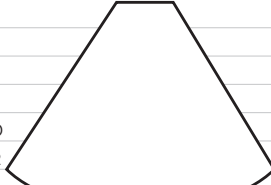

**93+ CRI**  
3000K, 3500K, 4000K (90 CRI)

**20° CBCP: 7109**

| Distance (feet) | FC*  | Diameter (feet) |
|-----------------|------|-----------------|
| 2               | 6043 | 0.7             |
| 4               | 445  | 1.3             |
| 6               | 197  | 2.0             |
| 8               | 111  | 2.7             |
| 10              | 71   | 3.3             |
| 12              | 49   | 4.0             |



**30° CBCP: 3653**

| Distance (feet) | FC* | Diameter (feet) |
|-----------------|-----|-----------------|
| 2               | 914 | 1.1             |
| 4               | 229 | 2.1             |
| 6               | 101 | 3.2             |
| 8               | 57  | 4.3             |
| 10              | 37  | 5.3             |
| 12              | 26  | 6.4             |



**50° CBCP: 2428**

| Distance (feet) | FC* | Diameter (feet) |
|-----------------|-----|-----------------|
| 2               | 607 | 1.8             |
| 4               | 152 | 3.6             |
| 6               | 67  | 5.3             |
| 8               | 38  | 7.1             |
| 10              | 25  | 8.9             |
| 12              | 17  | 10.7            |

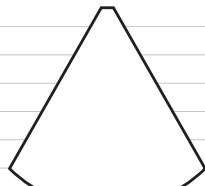

**70° CBCP: 1395**

| Distance (feet) | FC* | Diameter (feet) |
|-----------------|-----|-----------------|
| 2               | 349 | 2.7             |
| 4               | 88  | 5.3             |
| 6               | 39  | 7.9             |
| 8               | 22  | 10.6            |
| 10              | 14  | 13.2            |
| 12              | 9   | 15.9            |

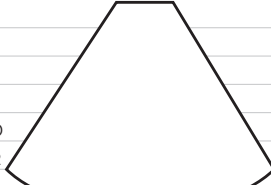

**SOLANDRA ORDERING INFORMATION**

| MODEL #         | TRACK                                  | FINISH                   | BEAM ANGLE                                   | CCT  | CRI  |
|-----------------|--|--------------------------|--|--|--|
| SOL - HE - 20 - | HT - H-Track<br>TK - Global 2C/2N 120V | WH - White<br>BK - Black | 20 - 20°<br>30 - 30°<br>50 - 50°<br>70 - 70° | 27 - 2700K<br>30 - 3000K<br>35 - 3500K<br>40 - 4000K | 80 - 80 CRI<br>93 - HIGH CRI*<br><br>*93+ CRI for 2700K, 3000K, 3500K<br>90+ CRI for 4000K |